

TEST REPORT

Product Name : Adapter Box
Model Number : Adapter Box G2

Prepared for : SolaX Power Network Technology (Zhejiang) Co., Ltd.
Address : No.288, Shizhu Road, Tonglu Economic Development Zone,
Tonglu City, Zhejiang Province, 310000 P.R. China

Prepared by : EMTEK (DONGGUAN) CO., LTD.
Address : -1&2F., Building 2, Zone A, Zhongda Marine Biotechnology
Research and Development Base, No. 9, Xincheng Avenue,
Songshanhu High-technology Industrial Development Zone,
Dongguan, Guangdong, China

Tel : +86-0769-22807078
Fax: +86-0769-22807079

Report Number : EDG2209290149E01402R
Date(s) of Tests : September 29, 2022 to January 16, 2023
Date of Issue : January 17, 2023



TABLE OF CONTENTS

1. TEST RESULT CERTIFICATION	3
2. EUT DESCRIPTION	3
3. INFORMATION AS REQUIRED BY EN 300 328 V2.2.2	5
4. SUMMARY OF TEST RESULT	8
5. TEST METHODOLOGY	9
5.1 GENERAL DESCRIPTION OF APPLIED STANDARDS	9
5.2 MEASUREMENT EQUIPMENT USED	9
5.3 DESCRIPTION OF TEST MODES	11
5.4 TEST SOFTWARE	11
6. FACILITIES AND ACCREDITATIONS	12
6.1 FACILITIES	12
6.2 EQUIPMENT	12
6.3 LABORATORY ACCREDITATIONS AND LISTINGS	12
7. TEST SYSTEM UNCERTAINTY	13
8. SETUP OF EQUIPMENT UNDER TEST	14
8.1 SETUP CONFIGURATION OF EUT	14
8.2 SUPPORT EQUIPMENT	15
9. ETSI EN 300 328 REQUIREMENTS	16
9.1 RF OUTPUT POWER	16
9.2 POWER SPECTRAL DENSITY	19
9.3 OCCUPIED CHANNEL BANDWIDTH	25
9.4 TRANSMITTER UNWANTED EMISSION IN THE OUT-OF BAND	30
9.5 TRANSMITTER UNWANTED EMISSIONS IN THE SPURIOUS DOMAIN	36
9.6 RECEIVER SPURIOUS EMISSIONS	41
9.7 ADAPTIVITY (ADAPTIVE EQUIPMENT USING MODULATIONS OTHER THAN FHSS)	45
9.8 RECEIVER BLOCKING	53
10. APPENDIX PHOTOGRAPHS OF TEST SETUP	58

1. TEST RESULT CERTIFICATION

Applicant : SolaX Power Network Technology (Zhejiang) Co. ,Ltd.
 Address : No.288,Shizhu Road, Tonglu Economic Development Zone, Tonglu City, Zhejiang Province, 310000 P.R. China
 Manufacturer : SolaX Power Network Technology (Zhejiang) Co. ,Ltd.
 Address : No.288,Shizhu Road, Tonglu Economic Development Zone, Tonglu City, Zhejiang Province, 310000 P.R. China
 EUT : Adapter Box
 Model Name : Adapter Box G2
 Trademark : SolaX Power

Measurement Procedure Used:

APPLICABLE STANDARDS	
STANDARD	TEST RESULT
ETSI EN 300 328 v2.2.2: 2019	PASS

The device described above is tested by EMTEK (DONGGUAN) CO., LTD. to determine the maximum emission levels emanating from the device and the severe levels of the device can endure and its performance criterion. The measurement results are contained in this test report and EMTEK (DONGGUAN) CO., LTD. is assumed full of responsibility for the accuracy and completeness of these measurements. Also, this report shows that the EUT (Equipment Under Test) is technically compliant with the ETSI EN 300 328 v2.2.2: 2019 requirements.

This report applies to above tested sample only and shall not be reproduced in part without written approval of EMTEK (DONGGUAN) CO., LTD.

Date of Test : September 29, 2022 to January 16, 2023

Prepared by : Warren Deng
 Warren deng /Engineer

Reviewer : Tim Dong
 Tim Dong /Supervisor

Approved & Authorized Signer : Sam Lv
 Sam Lv /Manager



2. EUT DESCRIPTION

Product:	Adapter Box
Model Number:	Adapter Box G2
Sample Number:	1#
WIFI	
WLAN Supported:	<input checked="" type="checkbox"/> 802.11b <input checked="" type="checkbox"/> 802.11g <input checked="" type="checkbox"/> 802.11n(20MHz channel bandwidth) <input type="checkbox"/> 802.11n(40MHz channel bandwidth)
Modulation:	<input checked="" type="checkbox"/> DSSS with DBPSK/DQPSK/CCK for 802.11b <input checked="" type="checkbox"/> OFDM with BPSK/QPSK/16QAM/64QAM for 802.11g/n
Frequency Range:	<input checked="" type="checkbox"/> 2412-2472MHz for 802.11b/g/n(HT20) <input type="checkbox"/> 2422-2462MHz for 802.11n(HT40)
Number of Channels:	<input checked="" type="checkbox"/> 13 Channels for 802.11b/g/n(HT20) <input type="checkbox"/> 9 Channels for 802.11n(HT40)
Max Transmit Power:	17.94 dBm
Antenna:	PCB Antenna
Antenna Gain:	3.28 dBi
Test Voltage:	AC 100-240V, 50/60Hz
Adapter:	M/N: ABT020120A Input: AC 100-240V, 50/60Hz, 1.5A Output: DC 12V, 2A, 24W
Date of Received:	September 29, 2022
Temperature Range:	-40°C ~ +65°C

Note: for more details, please refer to the User's manual of the EUT.

3. INFORMATION AS REQUIRED BY EN 300 328 V2.2.2

EN 300 328	Information Is Provided By The Manufacturer	
The type of modulation used by the equipment	<input type="checkbox"/> FHSS <input checked="" type="checkbox"/> other forms of modulation	
Adaptive/non-adaptive equipment:	<input type="checkbox"/> non-adaptive Equipment <input checked="" type="checkbox"/> adaptive Equipment without the possibility to switch to a non-adaptive mode <input type="checkbox"/> adaptive Equipment which can also operate in a non-adaptive mode	
In case of adaptive equipment:	<p>The maximum Channel Occupancy Time implemented by the equipment: 2.904 ms</p> <input checked="" type="checkbox"/> The equipment has implemented an LBT based DAA mechanism <ul style="list-style-type: none"> ● In case of equipment using modulation different from FHSS: <ul style="list-style-type: none"> <input type="checkbox"/> The equipment is Frame Based equipment <input checked="" type="checkbox"/> The equipment is Load Based equipment <input type="checkbox"/> The equipment can switch dynamically between Frame Based and Load Based equipment <p>The CCA time implemented by the equipment: 129.33 μs</p> <input type="checkbox"/> The equipment has implemented an non-LBT based DAA mechanism <input type="checkbox"/> The equipment can operate in more than one adaptive mode	
The worst case operational mode for each of the following tests:	RF Output Power Power Spectral Density Duty Cycle, Tx-Sequence, Tx-gap. Dwell Time, Minimum Frequency Occupation & Hopping Sequence (only for FHSS equipment) Hopping Frequency Separation (only for FHSS equipment) Medium Utilisation. Adaptivity Receiver Blocking Occupied Channel Bandwidth Transmitter Unwanted Emissions in the OOB domain. Transmitter Unwanted Emissions in the spurious domain Receiver spurious emissions	17.94 dBm 9.18 dBm/MHz N/A N/A N/A N/A Pass Pass 17.551 MHz Pass Pass Pass

<p>The different transmit operating modes (tick all that apply):</p>	<ul style="list-style-type: none"> <input checked="" type="checkbox"/> Operating mode 1: Single Antenna Equipment <ul style="list-style-type: none"> <input checked="" type="checkbox"/> Equipment with only 1 antenna <input type="checkbox"/> Equipment with 2 diversity antennas but only 1 antenna active at any moment in time <input type="checkbox"/> Smart Antenna Systems with 2 or more antennas, but operating in a (legacy) mode where only 1 antenna is used. (e.g. IEEE 802.11™ [i.3] legacy mode in smart antenna systems) <input type="checkbox"/> Operating mode 2: Smart Antenna Systems - Multiple Antennas without beam forming <ul style="list-style-type: none"> <input type="checkbox"/> Single spatial stream / Standard throughput / (e.g. IEEE 802.11™ [i.3] legacy mode) <input type="checkbox"/> High Throughput (> 1 spatial stream) using Occupied Channel Bandwidth 1 <input type="checkbox"/> High Throughput (> 1 spatial stream) using Occupied Channel Bandwidth 2 <input type="checkbox"/> Operating mode 3: Smart Antenna Systems - Multiple Antennas with beam forming <ul style="list-style-type: none"> <input type="checkbox"/> Single spatial stream / Standard throughput (e.g. IEEE 802.11™ [i.3] legacy mode) <input type="checkbox"/> High Throughput (> 1 spatial stream) using Occupied Channel Bandwidth 1 <input type="checkbox"/> High Throughput (> 1 spatial stream) using Occupied Channel Bandwidth 2
<p>Operating Frequency Range(s) of the equipment:</p>	<p>Operating Frequency Range: 2412 MHz to 2472 MHz</p>
<p>Occupied Channel Bandwidth(s):</p>	<p>Occupied Channel Bandwidth: 17.551 MHz</p>
<p>Type of Equipment (stand-alone, combined, plug-in radio device, etc.):</p>	<ul style="list-style-type: none"> <input checked="" type="checkbox"/> Stand-alone <input type="checkbox"/> Combined Equipment (Equipment where the radio part is fully integrated within another type of equipment) <input type="checkbox"/> Plug-in radio device (Equipment intended for a variety of host systems) <input type="checkbox"/> Other
<p>Describe the test modes available which can facilitate testing:</p>	<p>Modulation Mode: DSSS with DBPSK/DQPSK/CCK for OFDM with 802.11b; BPSK/QPSK/16QAM/64QAM for 802.11g/n; Test Frequency: Low Frequency, Middle Frequency, High Frequency</p>
<p>The equipment type (e.g. Bluetooth®, IEEE 802.11™ [i.3], proprietary, etc.):</p>	<p>802.11b/g/n(HT20)</p>
<p>NOTE: N/A means not applicable</p>	

Modified Information

Version	Report No.	Revision Date	Summary
/	EDG2209290149E01402R	/	Original Report



4. SUMMARY OF TEST RESULT

Clause (EN 300 328)	Test Parameter	Verdict	Remark
4.3.2.2	RF Output Power	PASS	
4.3.2.3	Power Spectral Density	PASS	
4.3.2.4	Duty Cycle and Tx-Sequence and Tx-Gap	N/A (See Note1)	Only applicable for non-adaptive equipment Output Power >10dBm
4.3.2.5	Medium Utilisation Factor	N/A (See Note1)	Only applicable for non-adaptive equipment Output Power >10dBm
4.3.2.6	Adaptivity (adaptive equipment using modulations other than FHSS)	PASS	
4.3.2.7	Occupied Channel Bandwidth	PASS	
4.3.2.8	Transmitter Unwanted Emission in the Out-of Band	PASS	
4.3.2.9	Transmitter Unwanted Emissions in the Spurious Domain	PASS	
4.3.2.10	Receiver Spurious Emissions	PASS	
4.3.2.11	Receiver Blocking	PASS (See Note2)	Receiver category 1
<p>NOTE1: N/A (Not Applicable)</p> <p>NOTE2: Receiver category 1(Adaptive equipment with a maximum RF output power greater than 10 dBm e.i.r.p. shall be considered as receiver category 1 equipment.)</p> <p>Receiver category 2(Non-adaptive equipment with a Medium Utilization (MU) factor greater than 1 % and less than or equal to 10 % or adaptive equipment with a maximum RF output power of 10 dBm e.i.r.p. shall be considered as receiver category 2 equipment.)</p> <p>Receiver category 3(Non-adaptive equipment with a maximum Medium Utilization (MU) factor of 1 % or adaptive equipment with a maximum RF output power of 0 dBm e.i.r.p. shall be considered as receiver category 3 equipment.)</p>			

5. TEST METHODOLOGY

5.1 GENERAL DESCRIPTION OF APPLIED STANDARDS

ETSI EN 300 328 –Wideband transmission systems; Data transmission equipment operating in the 2,4 GHz ISM band and using wide band modulation techniques; Harmonised Standard covering the essential requirements of article 3.2 of Directive 2014/53/EU

5.2 MEASUREMENT EQUIPMENT USED

For spurious emissions test

Equ. No.	Equipment	Manufacturer	Model No.	Serial No.	Last Cal.	Cal. Interval
ENE-002	Spectrum Analyzer	Rohde & Schwarz	ESCI	101107	July 07, 2022	1 Year
ENE-002	EMI Test Receiver	Rohde & Schwarz	ESCI	101107	July 07, 2022	1 Year
ENE-009	Pre-Amplifier	CD	PAP-0203	22015	July 07, 2022	1 Year
ENE-010	Bilog Antenna	Schwarzbeck	VULB9163	9163-467	July 11, 2022	2 Year
ENE-025-1	Cable	Huber + Suhner	CBL3-NN-0.5M	101216-2140500-2	July 07, 2022	1 Year
ENE-025-2	Cable	Huber + Suhner	CBL3-NN-3.0M	101216-2143000-2	July 07, 2022	1 Year
ENE-025-3	Cable	Huber + Suhner	CBL3-NN-9.0M	101216-2149000	July 07, 2022	1 Year
ENE-170	EXA Signal Analyzer	KEYSIGHT	N9010B	MY60242457	March 01, 2022	1 Year
ENE-090	Pre-Amplifier	Connphy Microwave Inc.	GLN-1G40G-4165-K	0319104	Nov 22, 2022	1 Year
ENE-192	Horn Antenna	Schwarzbeck	BBHA 9120 D	02589	May 27, 2022	2 Year
ENE-101-1	Cable	SMAMSMAM	A50-0.5M	N/A	July 07, 2022	1 Year
ENE-101-2	Cable	SMAMSMAM	A50-3M	N/A	July 07, 2022	1 Year
ENE-101-4	Cable	SMAMSMAM	A50-6M	N/A	July 07, 2022	1 Year

For other test items:

Equ. No.	Equipment	Manufacturer	Model No.	Serial No.	Last Cal.	Cal. Interval
ENE-253	EXG Analog Singnal Generator	Keysight	N5173B	MY61253062	July 05, 2022	1 Year
ENE-254	MXG Vector Singnal Generator	Keysight	N5182B	MY61350131	July 05, 2022	1 Year
ENE-255	Frepquency Extender	Keysight	N5183BX07	MY61500104	July 05, 2022	1 Year
ENE-256	EXA Signal Anaalyzer	Keysight	N9010B	MY62060219	July 05, 2022	1 Year
ENE-257	WIRELESS CONNECTIVITY TESTER	ROHDE & SCHWARZ	CMW 270	1201.0002K75-102608-Pb	July 05, 2022	1 Year

ENE-257-1	Up/Down-Converter	ROHDE & SCHWARZ	CMW-Z800A	1211.4530.02	/	/
ENE-172	RF Control Unit	Tonscend	JS0806-2(V.6E)	21L8060521	March 01, 2022	1 Year
ENE-092	DC Power Supply	KEFUNA	KDP3603	2004D3062946	July 07, 2022	1 Year
ENE-093	Attenuator 10dB	talent Microwave	TA10A2-S-18	N/A	July 07, 2022	1 Year



5.3 DESCRIPTION OF TEST MODES

The EUT has been tested under its typical operating condition.

The EUT configuration for testing is installed on RF field strength measurement to meet the Commissions requirement and operating in a manner which intends to maximize its emission characteristics in a continuous normal application.

The Transmitter was operated in the normal operating mode. The TX frequency was fixed which was for the purpose of the measurements.

Test of channel included the lowest and middle and highest frequency to perform the test, then record on this report.

The EUT has been tested under its typical operating condition. so those data rates (802.11b: 1 Mbps; 802.11g: 6 Mbps; 802.11n(HT20): MCS0;) were used for all test.

Pre-defined engineering program for regulatory testing used to control the EUT for staying in continuous transmitting and receiving mode is programmed.

The test software contains the following patterns:

Frequency and Channel list for 802.11b/g/n (HT20):

Channel	Frequency (MHz)	Channel	Frequency (MHz)	Channel	Frequency (MHz)
1	2412	5	2432	10	2457
2	2417	6	2437	11	2462
3	2422	7	2442	12	2467
4	2427	8	2447	13	2472
		9	2452		

Frequency and Channel list for 802.11n (HT40):

Channel	Frequency (MHz)	Channel	Frequency (MHz)	Channel	Frequency (MHz)
3	2422	6	2437	9	2452
4	2427	7	2442	10	2457
5	2432	8	2447	11	2462

Test Frequency and Channel for 802.11b/g/n(HT20):

Lowest Frequency		Middle Frequency		Highest Frequency	
Channel	Frequency (MHz)	Channel	Frequency (MHz)	Channel	Frequency (MHz)
1	2412	7	2442	13	2472

5.4 TEST SOFTWARE

Item	Software
RF Conducted:	ETSI Certification of Regulations Test Solution(V1.04.01)
Radiated Emission:	EMTEK(Ver.RA-03A1)-Shenzhen

6. FACILITIES AND ACCREDITATIONS

6.1 FACILITIES

All measurement facilities used to collect the measurement data are located at EMTEK (DONGGUAN) CO., LTD.

-1&2F., Building 2, Zone A, Zhongda Marine Biotechnology Research and Development Base, No. 9, Xincheng Avenue, Songshanhu High-technology Industrial Development Zone, Dongguan, Guangdong, China

The sites are constructed in conformance with the requirements of ANSI C63.7, ANSI C63.10 and CISPR Publication 32.

6.2 EQUIPMENT

Radiated emissions are measured with one or more of the following types of linearly polarized antennas: tuned dipole, biconical, log periodic, bi-log, and/or ridged waveguide, horn. Spectrum analyzers with preselectors and quasi-peak detectors are used to perform radiated measurements.

Conducted emissions are measured with Line Impedance Stabilization Networks and EMI Test Receivers.

Calibrated wideband preamplifiers, coaxial cables, and coaxial attenuators are also used for making measurements.

All receiving equipment conforms to CISPR Publication 16-1, "Radio Interference Measuring Apparatus and Measurement Methods."

6.3 LABORATORY ACCREDITATIONS AND LISTINGS

Site Description

EMC Lab. : Accredited by CNAS, 2020.08.27
The certificate is valid until 2024.07.05
The Laboratory has been assessed and proved to be in compliance with CNAS/CL01:2018
The Certificate Registration Number is L3150

Accredited by FCC
Designation Number: CN1300
Test Firm Registration Number: 945551

Accredited by A2LA, April 05, 2021
The Certificate Registration Number is 4321.02

Accredited by Industry Canada
The Certificate Registration Number is CN0113

Name of Firm : EMTEK (DONGGUAN) CO., LTD.
Site Location : -1&2F., Building 2, Zone A, Zhongda Marine Biotechnology Research and Development Base, No. 9, Xincheng Avenue, Songshanhu High-technology Industrial Development Zone, Dongguan, Guangdong, China

7. TEST SYSTEM UNCERTAINTY

Maximum measurement uncertainty of the test system

Test Parameter	Measurement Uncertainty
RF Output Power	±1.0%
Power Spectral Density	±0.9%
Duty Cycle and Tx-Sequence and Tx-Gap	±1.3%
Medium Utilisation Factor	±1.5%
Occupied Channel Bandwidth	±2.3%
Transmitter Unwanted Emission in the Out-of Band	±1.2%
Transmitter Unwanted Emissions in the Spurious Domain	±2.7%
Receiver Spurious Emissions	±2.7%
Temperature	±3.2%
Humidity	±2.5%



8. SETUP OF EQUIPMENT UNDER TEST

8.1 SETUP CONFIGURATION OF EUT

Conducted measurements configuration of EUT shall be as follows:

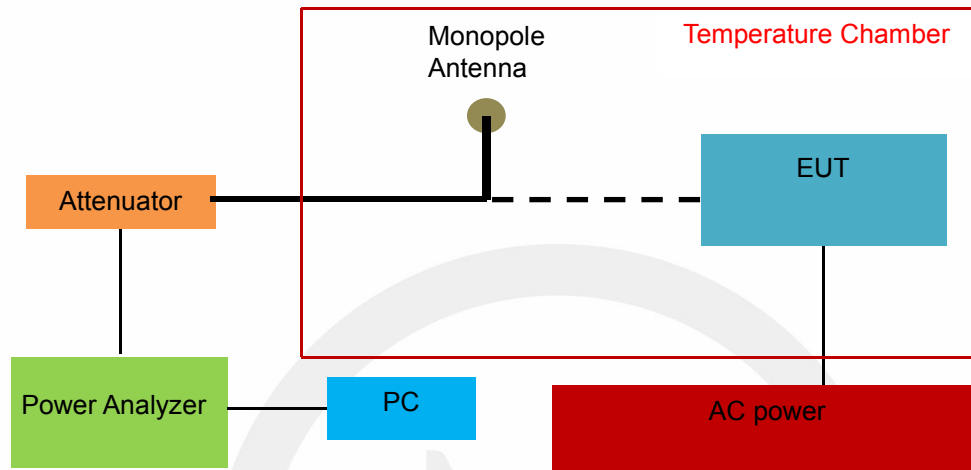

Remarks:

The Signal Analyzer could be connected to a monopole antenna or directly connected to the EUT, if the EUT has already employing an antenna connector.

Radiated measurements configuration of EUT shall be as follows:

Below 1GHz

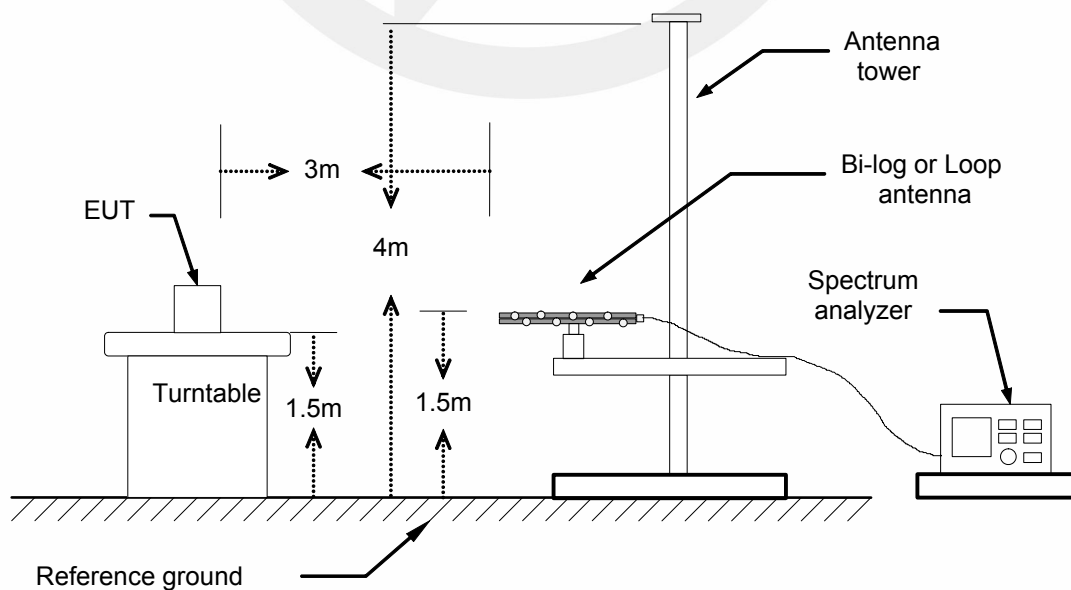

Above 1GHz

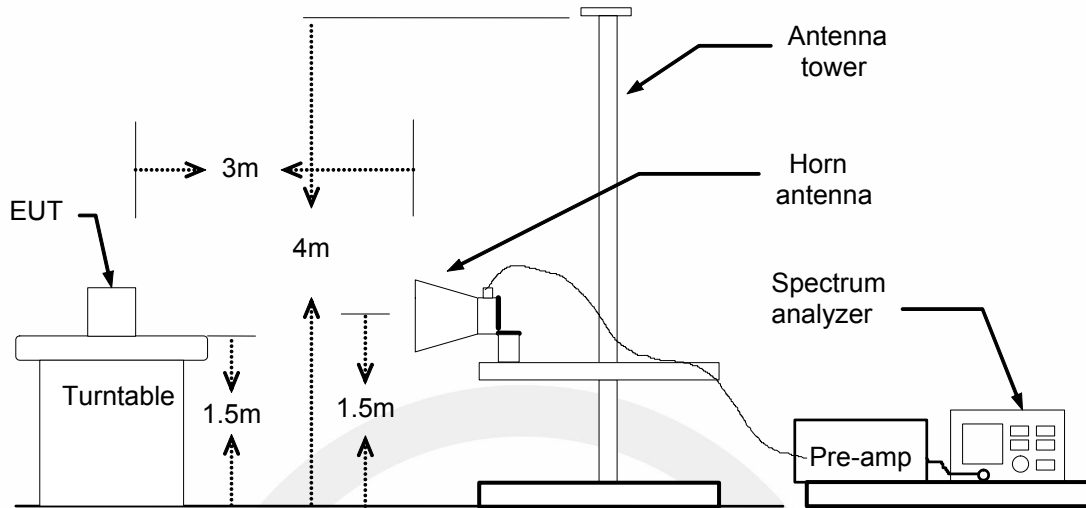

8.2 SUPPORT EQUIPMENT

EUT Cable List and Details			
Cable Description	Length (m)	Shielded/Unshielded	With / Without Ferrite

Auxiliary Cable List and Details			
Cable Description	Length (m)	Shielded/Unshielded	With / Without Ferrite
/	/	/	/

Auxiliary Equipment List and Details			
Description	Manufacturer	Model	Serial Number

Notes:

1. All the equipment/cables were placed in the worst-case configuration to maximize the emission during the test.
2. Grounding was established in accordance with the manufacturer's requirements and conditions for the intended use.
3. Unless otherwise denoted as EUT in 『Remark』 column , device(s) used in tested system is a support equipment

9. ETSI EN 300 328 REQUIREMENTS

9.1 RF OUTPUT POWER

9.1.1 Applicable standard

EN 300 328 Clause 4.3.2.2

9.1.2 Conformance Limit

The Maximum RF Output Power \leq 100 mW (20 dBm) (EIRP) at both Normal and Extreme conditions.

9.1.3 Test Configuration

The measurements for RF output power shall be performed at both normal environmental conditions and at the extremes of the operating temperature range.

Radiated measurements shall only be used for integral antenna equipment that does not have a temporary antenna connector(s) provided.

Conducted measurements shall be used for antenna equipment provided a temporary antenna connector(s)

9.1.4 Test Procedure

1. Please refer to ETSI EN 300 328 (V2.2.2) clause 5.4.2.1 for the test conditions.
2. Please refer to ETSI EN 300 328 (V2.2.2) clause 5.4.2.2 for the measurement method.

The test procedure shall be as follows:

■ Conducted measurements

Step 1:

- Use a fast power sensor with a minimum sensitivity of -40 dBm and capable of minimum 1 MS/s.
- Use the following settings:
 - Sample speed 1 MS/s or faster.
 - The samples shall represent the RMS power of the signal.
 - Measurement duration: For non-adaptive equipment: equal to the observation period defined in clause 4.3.1.3.2 or clause 4.3.2.4.2. For adaptive equipment, the measurement duration shall be long enough to ensure a minimum number of bursts (at least 10) are captured.

For adaptive equipment, to increase the measurement accuracy, a higher number of bursts may be used.

Step 2:

- For conducted measurements on devices with one transmit chain:
 - Connect the power sensor to the transmit port, sample the transmit signal and store the raw data.

Use

these stored samples in all following steps.

- For conducted measurements on devices with multiple transmit chains:
 - Connect one power sensor to each transmit port for a synchronous measurement on all transmit ports.
 - Trigger the power sensors so that they start sampling at the same time. Make sure the time difference between the samples of all sensors is less than 500 ns.

- For each individual sampling point (time domain), sum the coincident power samples of all ports and

store them. Use these summed samples in all following steps.

Step 3:

- Find the start and stop times of each burst in the stored measurement samples.

The start and stop times are defined as the points where the power is at least 30 dB below the highest value of the stored samples in step 2.

In case of insufficient dynamic range, the value of 30 dB may need to be reduced appropriately.

Step 4:

• Between the start and stop times of each individual burst calculate the RMS power over the burst using the formula below. Save these Pburst values, as well as the start and stop times for each burst.

$$P_{burst} = \frac{1}{k} \sum_{n=1}^k P_{sample}(n)$$

with k being the total number of samples and n the actual sample number.

Step 5:

• The highest of all Pburst values (value "A" in dBm) will be used for maximum e.i.r.p. calculations.

Step 6:

- Add the (stated) antenna assembly gain "G" in dBi of the individual antenna.
- If applicable, add the additional beamforming gain "Y" in dB.
- If more than one antenna assembly is intended for this power setting, the maximum overall antenna gain (G or G + Y) shall be used.
- The RF Output Power (P) shall be calculated using the formula below: $P = A + G + Y$
- This value, which shall comply with the limit given in clause 4.3.1.2.3 or clause 4.3.2.2.3, shall be recorded in the test report.

■ Radiated measurements

This method shall only be used for integral antenna equipment that does not have a temporary antenna connector(s) provided.

When performing radiated measurements, the UUT shall be configured and antenna(s) positioned (including smart antenna systems and equipment capable of beamforming) for maximum e.i.r.p. towards the measuring antenna. This position shall be recorded.

A test site as described in annex B and applicable measurement procedures as described in annex C shall be used.

Taking into account the calibration factor from the measurement site, the test procedure for RF Output Power is further as described under clause 5.4.2.2.1.2, step 1 to step 5. The RF Output Power P is equal to the value A obtained in step 5. The test procedure for Duty Cycle, Tx-sequence, Tx-gap is further as described in clause 5.4.2.2.1.3 and the test procedure for Medium Utilization is further as described in clause 5.4.2.2.1.4.

9.1.5 Test Results

Test Conditions			Transmitter Power (dBm)		
			Temp (25)°C	Temp (-40)°C	Temp (65)°C
MODES	CHANNEL	VOLT POWER	AC 230V	AC 230V	AC 230V
☒ 802.11b	2412 MHz	RMS	17.83	17.33	17.76
	2442 MHz	RMS	17.86	17.56	17.67
	2472 MHz	RMS	17.94	17.64	17.65
☒ 802.11g	2412 MHz	RMS	12.59	12.11	12.25
	2442 MHz	RMS	12.87	12.73	12.69
	2472 MHz	RMS	13.12	13.09	13.08
☒ 802.11n (HT20)	2412 MHz	RMS	13.21	13.11	13.16
	2442 MHz	RMS	12.55	12.48	12.49
	2472 MHz	RMS	12.76	12.54	12.56
Limit			<= 20dBm		
Verdict			PASS	PASS	PASS

9.2 POWER SPECTRAL DENSITY

9.2.1 Applicable standard

According to ETSI EN 300 328 clause 4.3.2.3

9.2.2 Conformance Limit

The Maximum Power Spectrum Density ≤ 10 dBm/MHz

9.2.3 Test Configuration

The measurements for power spectral density shall only be performed at normal test conditions.

Radiated measurements shall only be used for integral antenna equipment that does not have a temporary antenna connector(s) provided.

Conducted measurements shall be used for antenna equipment provided a temporary antenna connector(s) provided.

9.2.4 Test Procedure

1. Please refer to ETSI EN 300 328 (V2.2.2) clause 5.4.3.1 for the test conditions.

2. Please refer to ETSI EN 300 328 (V2.2.2) clause 5.4.3.2 for the measurement method.

The test procedure shall be as follows:

■ Conducted measurement

● Option 1: For equipment with continuous and non-continuous transmissions

The transmitter shall be connected to a spectrum analyser and the Power Spectral Density (PSD) as defined in clause 4.3.2.3 shall be measured and recorded.

Step 1:

Connect the UUT to the spectrum analyser and use the following settings:

- Start Frequency: 2 400 MHz
- Stop Frequency: 2 483,5 MHz
- Resolution BW: 10 kHz
- Video BW: 30 kHz
- Sweep Points: > 8 350; for spectrum analysers not supporting this number of sweep points, the frequency band may be segmented
- Detector: RMS
- Trace Mode: Max Hold
- Sweep time: For non-continuous transmissions: $2 \times \text{Channel Occupancy Time} \times \text{number of sweep points}$

For continuous transmissions: 10 s; the sweep time may be increased further until a value where the sweep time has no further impact anymore on the RMS value of the signal.

For non-continuous signals, wait for the trace to stabilize.

Save the data (trace data) set to a file.

Step 2:

For conducted measurements on smart antenna systems using either operating mode 2 or operating mode 3 (see clause 5.3.2.2), repeat the measurement for each of the transmit ports. For each sampling point (frequency domain), add up the coincident power values (in mW) for the different transmit chains and use this as the new data set.

Step 3:

Add up the values for power for all the samples in the file using the formula below.

$$P_{burst} = \frac{1}{k} \sum_{n=1}^k P_{sample}(n)$$

with k being the total number of samples and n the actual sample number.

Step 4:

Normalize the individual values for power (in dBm) so that the sum is equal to the RF Output Power (e.i.r.p.) measured in clause 5.4.2 and save the corrected data. The following formulas can be used:

$$C_{Corr} = P_{Sum} - P_{e.i.r.p.}$$

$$P_{Samplecorr}(n) = P_{Sample}(n) - C_{Corr}$$

with n being the actual sample number

Step 5:

Starting from the first sample $P_{Samplecorr}(n)$ (lowest frequency), add up the power (in mW) of the following samples representing a 1 MHz segment and record the results for power and position (i.e. sample #1 to sample #100). This is the Power Spectral Density (e.i.r.p.) for the first 1 MHz segment which shall be recorded.

Step 6:

Shift the start point of the samples added up in step 5 by one sample and repeat the procedure in step 5 (i.e. sample #2 to sample #101).

Step 7:

Repeat step 6 until the end of the data set and record the Power Spectral Density values for each of the 1 MHz segments.

From all the recorded results, the highest value is the maximum Power Spectral Density (PSD) for the UUT. This value, which shall comply with the limit given in clause 4.3.2.3.3, shall be recorded in the test report.

- Option 2: For equipment with continuous transmission capability or for equipment operating (or This option is for equipment that can be configured to operate in a continuous transmit mode (100 % DC).

Step 1:

- Connect the UUT to the spectrum analyser and use the following settings:

- Centre Frequency: The centre frequency of the channel under test
- RBW: 1 MHz
- VBW: 3 MHz
- Frequency Span: At least $2 \times$ Occupied Channel Bandwidth
- Detector Mode: Peak
- Trace Mode: Max Hold

Step 2:

- When the trace is complete, find the peak value of the power envelope and record the frequency.

Step 3:

- Make the following changes to the settings of the spectrum analyser:

- Centre Frequency: Equal to the frequency recorded in step 2
- Frequency Span: 3 MHz
- RBW: 1 MHz
- VBW: 3 MHz
- Sweep Time: 1 minute
- Detector Mode: RMS
- Trace Mode: Max Hold

Step 4:

- When the trace is complete, the trace shall be captured using the "Hold" or "View" option on the spectrum analyser.

- Find the peak value of the trace and place the analyser marker on this peak. This level is recorded as the highest mean power (power spectral density) D in a 1 MHz band.

- Alternatively, where a spectrum analyser is equipped with a function to measure power spectral density, this function may be used to display the power spectral density D in dBm / MHz.

- In case of conducted measurements on smart antenna systems operating in a mode with multiple transmit chains active simultaneously, the power spectral density of each transmit chain shall be measured separately to calculate the total power spectral density (value D in dBm / MHz) for the UUT.

Step 5:

- The maximum Power Spectral Density (PSD) e.i.r.p. is calculated from the above measured power spectral density D, the applicable antenna assembly gain G in dBi and if applicable the beamforming gain Y in dB, according to the formula below. This value shall be recorded in the test report. If more than one antenna assembly is intended for this power setting, the gain of the antenna assembly with the highest gain shall be used.

$$PSD = D + G + Y \text{ (dBm / MHz)}$$

■Radiated measurement

When performing radiated measurements, the UUT shall be configured and antenna(s) positioned (including smart antenna systems and equipment capable of beamforming) for maximum e.i.r.p. towards the measuring antenna. This configuration/position shall be recorded for future use (see clause C.5.3.4 and clause C.5.4.4).

A test site as described in annex B and applicable measurement procedures as described in annex C shall be used.

Taking into account the calibration factor from the measurement site, the test procedure is further as described under clause 5.4.3.2.1.

9.2.5 Test Results

Test Condition		Measured Data (dBm/MHz)	Limit (dBm/MHz)	Verdict
☒ 802.11b	2412MHz	9.11	<=10	PASS
	2442 MHz	9.12	<=10	PASS
	2472 MHz	9.18	<=10	PASS
☒ 802.11g	2412MHz	0.93	<=10	PASS
	2442 MHz	1.28	<=10	PASS
	2472 MHz	1.65	<=10	PASS
☒ 802.11n (HT20)	2412MHz	1.32	<=10	PASS
	2442 MHz	0.77	<=10	PASS
	2472 MHz	1.11	<=10	PASS

All the modulation modes were tested; the data of the worst mode are described in the following table.

Power Spectral Density

- 802.11b 802.11g 802.11n(HT20) 802.11n(HT40)
 2412MHz 2422MHz 2442MHz 2462MHz 2472MHz

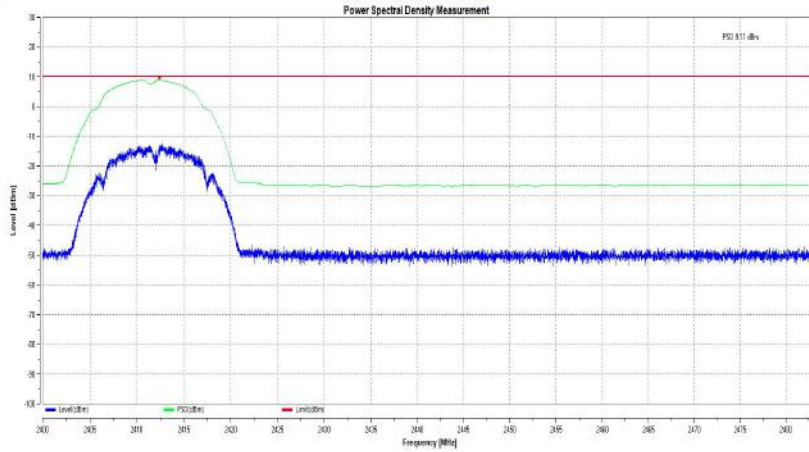

- 802.11b 802.11g 802.11n(HT20) 802.11n(HT40)
 2412MHz 2422MHz 2442MHz 2462MHz 2472MHz

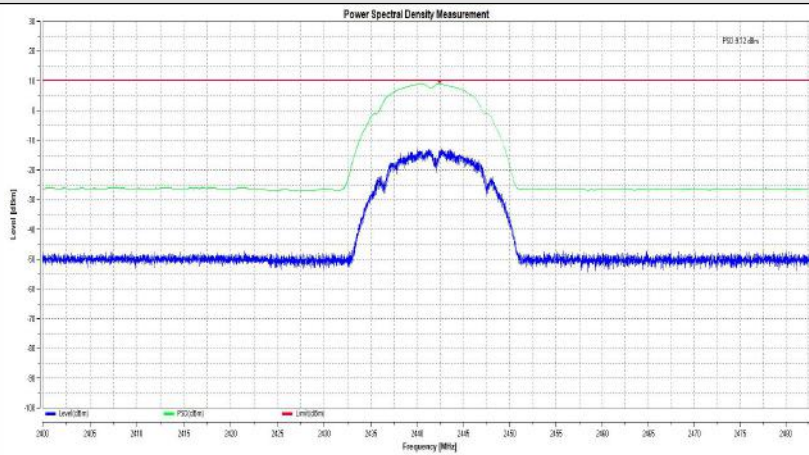

- 802.11b 802.11g 802.11n(HT20) 802.11n(HT40)
 2412MHz 2422MHz 2442MHz 2462MHz 2472MHz

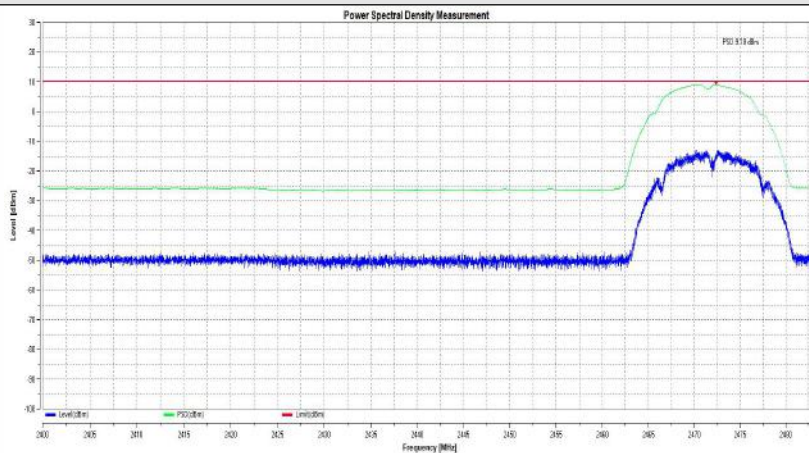

Power Spectral Density

- 802.11b 802.11g 802.11n(HT20) 802.11n(HT40)
 2412MHz 2422MHz 2442MHz 2462MHz 2472MHz

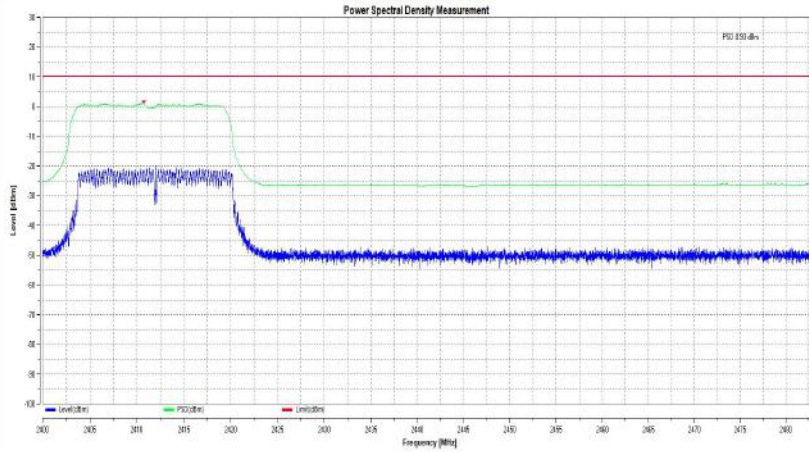

- 802.11b 802.11g 802.11n(HT20) 802.11n(HT40)
 2412MHz 2422MHz 2442MHz 2462MHz 2472MHz

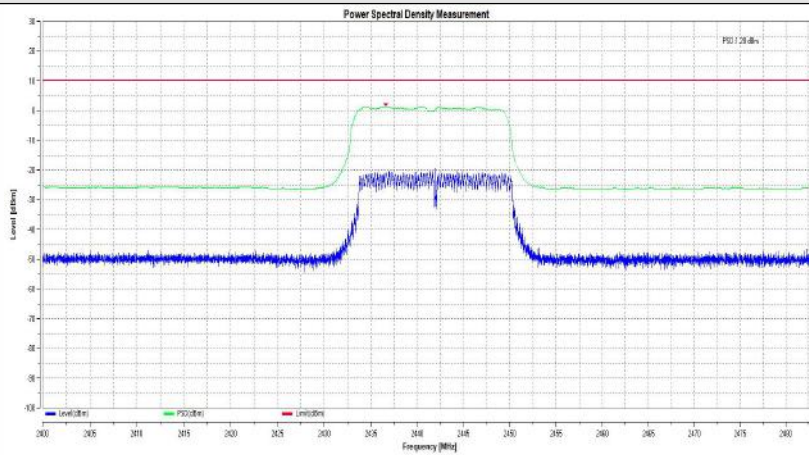

- 802.11b 802.11g 802.11n(HT20) 802.11n(HT40)
 2412MHz 2422MHz 2442MHz 2462MHz 2472MHz

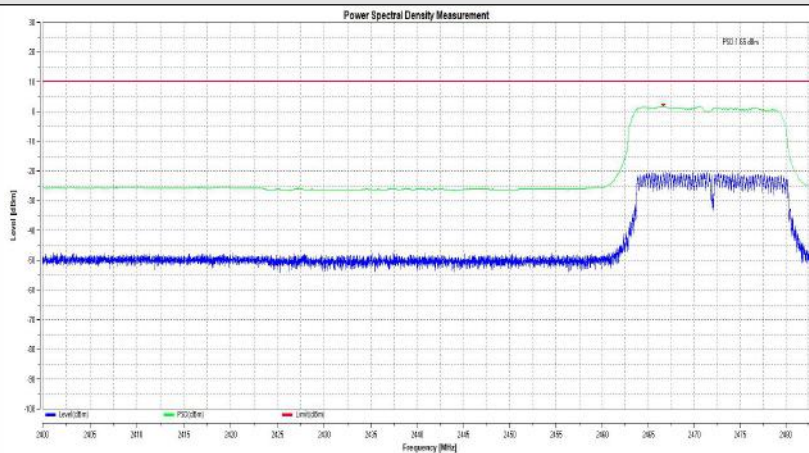

Power Spectral Density

- 802.11b 802.11g 802.11n(HT20) 802.11n(HT40)
 2412MHz 2422MHz 2442MHz 2462MHz 2472MHz

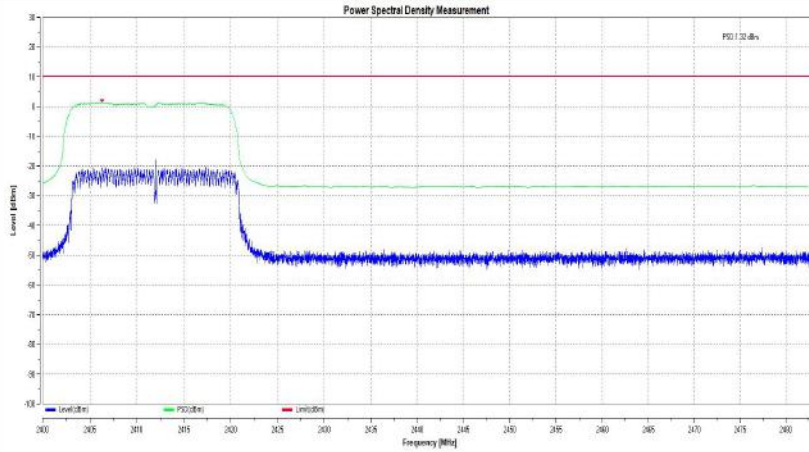

- 802.11b 802.11g 802.11n(HT20) 802.11n(HT40)
 2412MHz 2422MHz 2442MHz 2462MHz 2472MHz

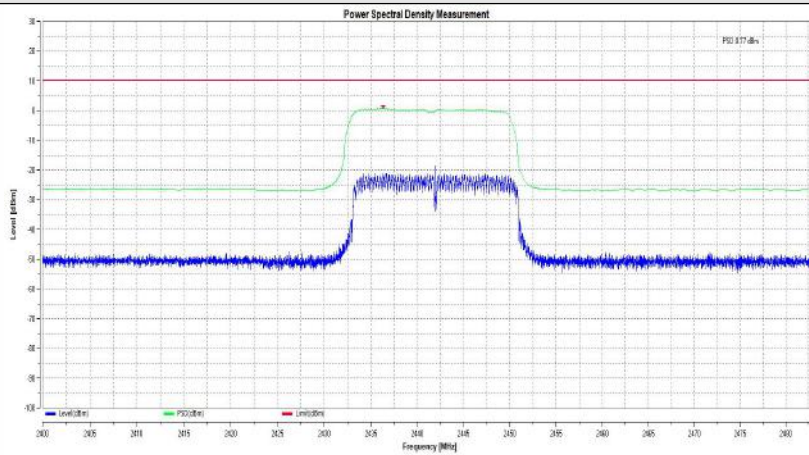

- 802.11b 802.11g 802.11n(HT20) 802.11n(HT40)
 2412MHz 2422MHz 2442MHz 2462MHz 2472MHz

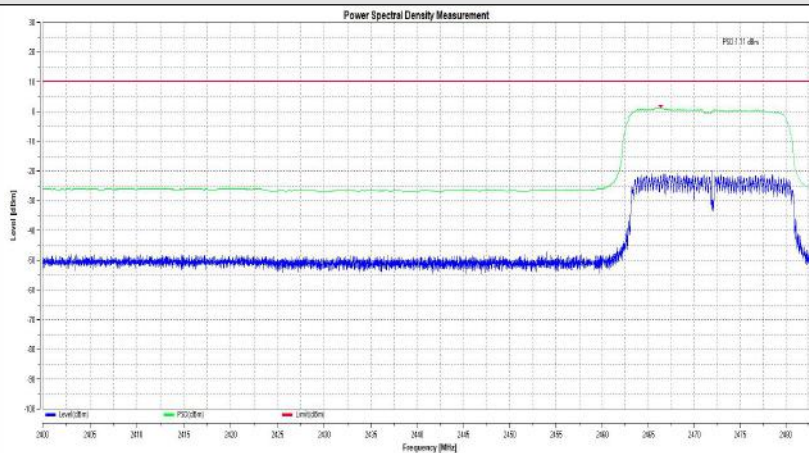

9.3 OCCUPIED CHANNEL BANDWIDTH

9.3.1 Applicable standard

ETSI EN 300 328 clause 4.3.2.7

9.3.2 Conformance Limit

The requirement applies to all types of equipment using wide band modulation other than FHSS

The occupied channel bandwidth is the bandwidth that contains 99% of the power of the signal

The Occupied Channel Bandwidth shall fall completely within the band 2400-2483.5MHz

In addition, for non-adaptive non-FHSS equipment with e.i.r.p. greater than 10 dBm, the Occupied Channel Bandwidth shall be equal to or less than 20 MHz

9.3.3 Test Configuration

The measurements for Occupied Channel Bandwidth shall only be performed at normal test conditions.

Radiated measurements shall only be used for integral antenna equipment that does not have a temporary antenna connector(s) provided.

Conducted measurements shall be used for antenna equipment provided a temporary antenna connector(s).

9.3.4 Test Procedure

1. Please refer to ETSI EN 300 328(V2.2.2) clause 5.4.7.1 for the test conditions.
2. Please refer to ETSI EN 300 328 (V2.2.2) clause 5.4.7.2 for the measurement method.

■Conducted measurement

The measurement procedure shall be as follows:

Step 1:

Connect the UUT to the spectrum analyser and use the following settings:

- Centre Frequency: The centre frequency of the channel under test
- Resolution BW: ~ 1 % of the span without going below 1 %
- Video BW: 3 × RBW
- Frequency Span: 2 × Nominal Channel Bandwidth
- Detector Mode: RMS
- Trace Mode: Max Hold
- Sweep time: 1 s

Step 2:

Wait for the trace to stabilize.

Find the peak value of the trace and place the analyser marker on this peak.

Step 3:

Use the 99 % bandwidth function of the spectrum analyser to measure the Occupied Channel Bandwidth of the UUT.

This value shall be recorded.

Make sure that the power envelope is sufficiently above the noise floor of the analyser to avoid the noise signals left and right from the power envelope being taken into account by this measurement.

■Radiated measurement

The test set up as described in annex B and the applicable measurement procedures described in annex C shall be used.

Alternatively, a test fixture may be used.

The test procedure is as described under clause 5.4.7.2.1.

9.3.5 Test Results

Temperature:		25°C			
Humidity:		55 % RH	Tested by:		XSJ
Operation Mode	Frequency (MHz)	OBW (MHz)	Test Frequency (MHz)	Limited (MHz)	Verdict
☒ 802.11b	2412 MHz	13.192	2405.3906	>2400.0	PASS
	2472 MHz	13.151	2478.5126	<2483.5	PASS
☒ 802.11g	2412 MHz	16.606	2403.6786	>2400.0	PASS
	2472 MHz	16.597	2480.2632	<2483.5	PASS
☒ 802.11n(HT20)	2412 MHz	17.551	2403.2103	>2400.0	PASS
	2472 MHz	17.534	2480.7316	<2483.5	PASS

All the modulation modes were tested, the data of the worst mode are described in the following table

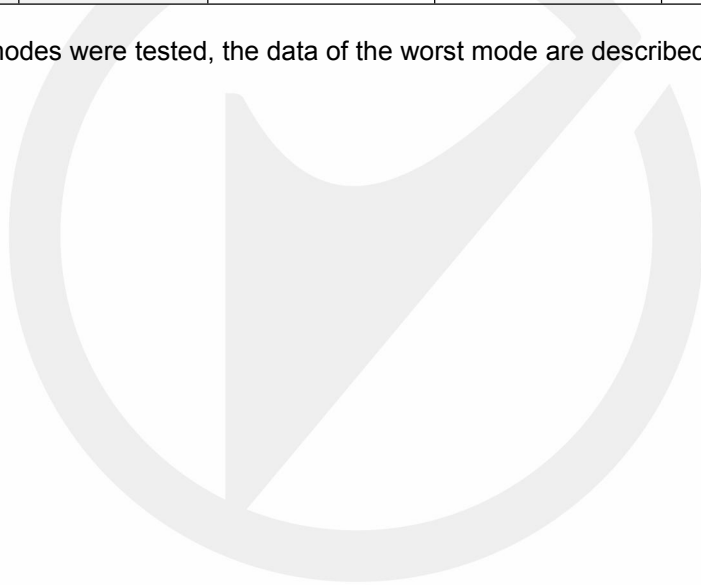

Occupied Channel Bandwidth

- 802.11b 802.11g 802.11n(HT20) 802.11n(HT40)
 2412MHz 2422MHz 2462MHz 2472MHz



Occupied Channel Bandwidth

- 802.11b 802.11g 802.11n(HT20) 802.11n(HT40)
 2412MHz 2422MHz 2462MHz 2472MHz



Occupied Channel Bandwidth

- 802.11b 802.11g 802.11n(HT20) 802.11n(HT40)
 2412MHz 2422MHz 2462MHz 2472MHz

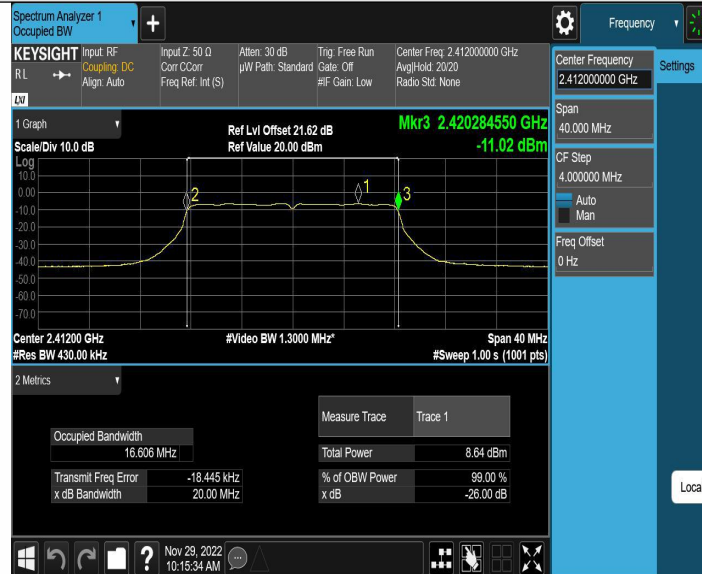

Occupied Channel Bandwidth

- 802.11b 802.11g 802.11n(HT20) 802.11n(HT40)
 2412MHz 2422MHz 2462MHz 2472MHz

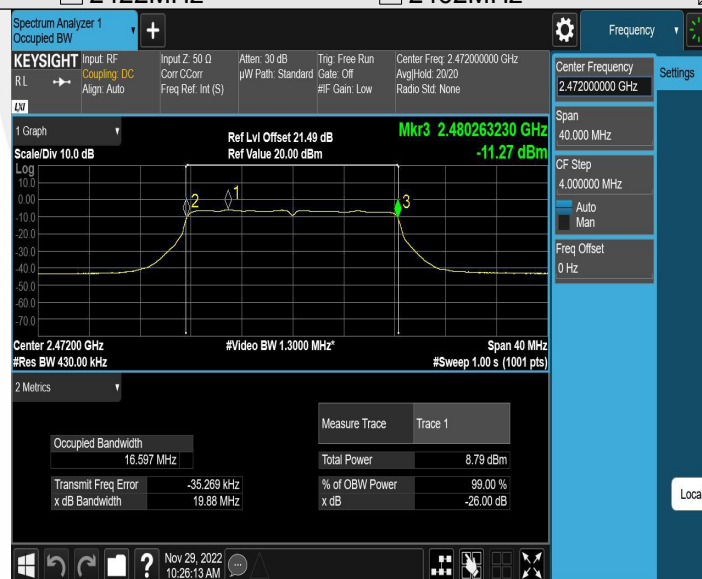

Occupied Channel Bandwidth

- 802.11b 802.11g 802.11n(HT20) 802.11n(HT40)
 2412MHz 2422MHz 2462MHz 2472MHz

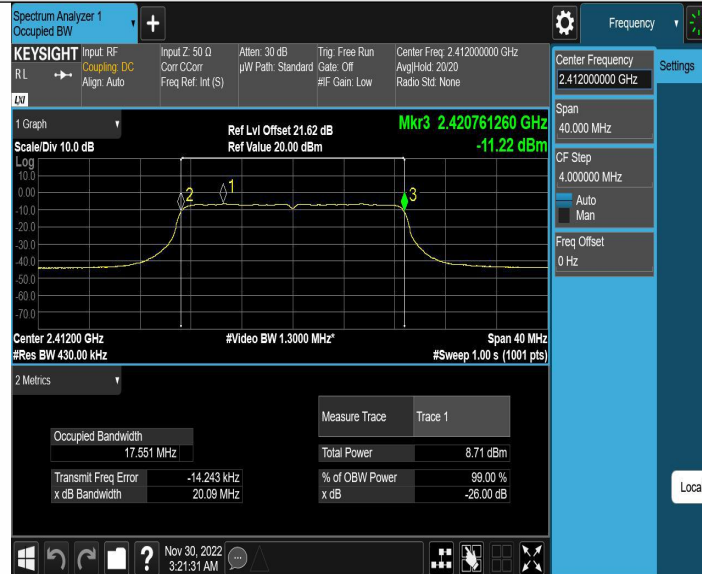

Occupied Channel Bandwidth

- 802.11b 802.11g 802.11n(HT20) 802.11n(HT40)
 2412MHz 2422MHz 2462MHz 2472MHz

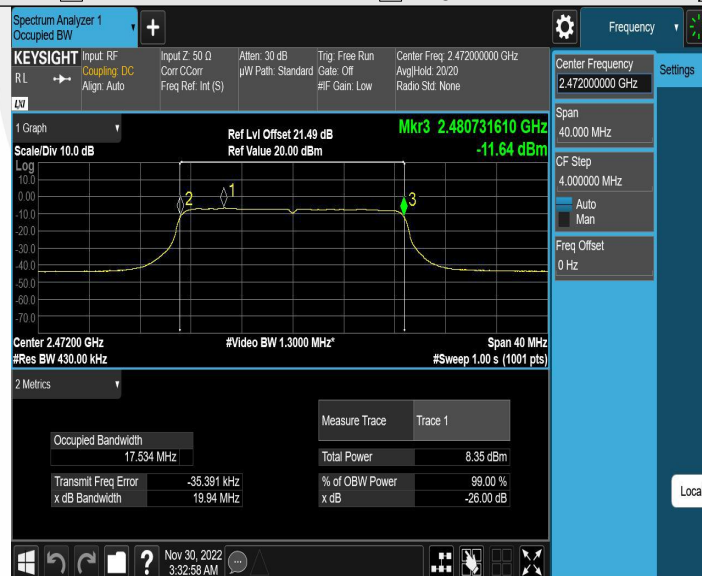

9.4 TRANSMITTER UNWANTED EMISSION IN THE OUT-OF BAND

9.4.1 Applicable standard

ETSI EN 300 328 clause 4.3.2.8

9.4.2 Conformance Limit

The transmitter unwanted emissions in the out-of-band domain but outside the allocated band, shall not exceed the limits of the mask given in below figure.

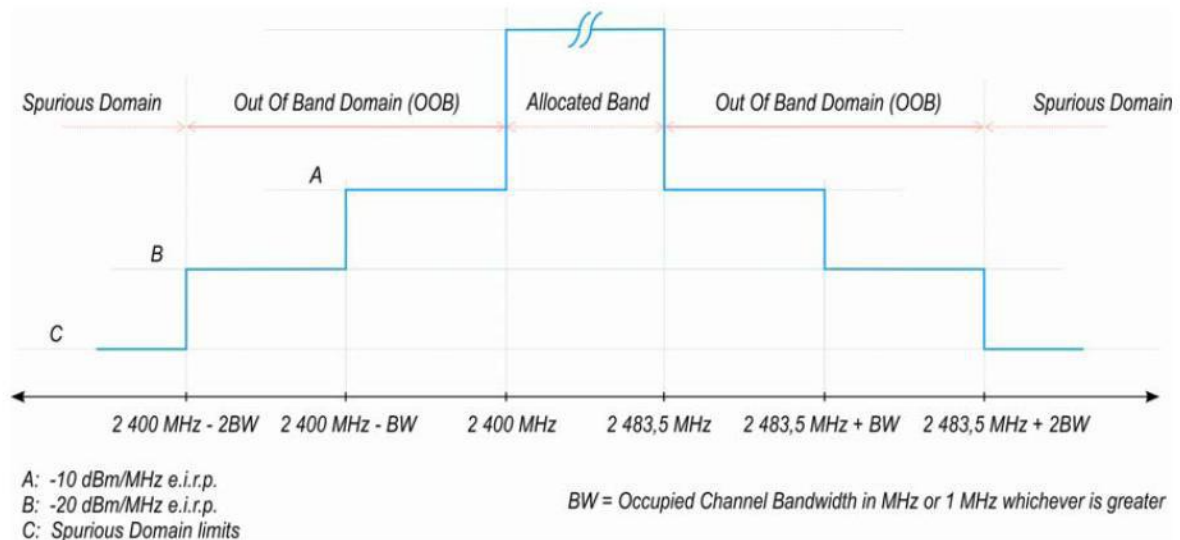

9.4.3 Test Configuration

The measurements for emission in the out-of band shall only be performed at normal test conditions.

Radiated measurements shall only be used for integral antenna equipment that does not have a temporary antenna connector(s) provided.

Conducted measurements shall be used for antenna equipment provided a temporary antenna connector(s).

9.4.4 Test Procedure

1. Please refer to ETSI EN 300 328 (V2.2.2) clause 5.4.8.1 for the test conditions.
2. Please refer to ETSI EN 300 328 (V2.2.2) clause 5.4.8.2 for the measurement method.

■ Conducted measurement

The applicable mask is defined by the measurement results from the tests performed under clause 5.4.7 (Occupied Channel Bandwidth).

The Out-of-band emissions within the different horizontal segments of the mask provided in figure 1 and figure 3 shall be measured using the procedure in step 1 to step 6 below. This method assumes the spectrum analyser is equipped with the Time Domain Power option.

Step 1:

- Connect the UUT to the spectrum analyser and use the following settings:
 - Measurement Mode: Time Domain Power
 - Centre Frequency: 2 484 MHz
 - Span: 0 Hz
 - Resolution BW: 1 MHz
 - Filter mode: Channel filter

- Video BW: 3 MHz
- Detector Mode: RMS
- Trace Mode: Max Hold
- Sweep Mode: Single Sweep
- Sweep Points: Sweep time [μ s] / (1 μ s) with a maximum of 30 000
- Trigger Mode: Video
- Sweep Time: > 120 % of the duration of the longest burst detected during the measurement of the RF Output Power

Step 2 (segment 2 483,5 MHz to 2 483,5 MHz + BW):

- Adjust the trigger level to select the transmissions with the highest power level.
- For frequency hopping equipment operating in a normal hopping mode, the different hops will result in signal bursts with different power levels. In this case the burst with the highest power level shall be selected.
- Set a window (start and stop lines) to match with the start and end of the burst and in which the RMS power shall be measured using the Time Domain Power function.
- Select RMS power to be measured within the selected window and note the result which is the RMS power within this 1 MHz segment (2 483,5 MHz to 2 484,5 MHz). Compare this value with the applicable limit provided by the mask.
- Increase the centre frequency in steps of 1 MHz and repeat this measurement for every 1 MHz segment within the range 2 483,5 MHz to 2 483,5 MHz + BW. The centre frequency of the last 1 MHz segment shall be set to 2 483,5 MHz + BW - 0,5 MHz (which means this may partly overlap with the previous 1 MHz segment).

Step 3 (segment 2 483,5 MHz + BW to 2 483,5 MHz + 2BW):

- Change the centre frequency of the analyser to 2 484 MHz + BW and perform the measurement for the first 1 MHz segment within range 2 483,5 MHz + BW to 2 483,5 MHz + 2BW. Increase the centre frequency in 1 MHz steps and repeat the measurements to cover this whole range. The centre frequency of the last 1 MHz segment shall be set to 2 483,5 MHz + 2 BW - 0,5 MHz (which means this may partly overlap with the previous 1 MHz segment).

Step 4 (segment 2 400 MHz - BW to 2 400 MHz):

- Change the centre frequency of the analyser to 2 399,5 MHz and perform the measurement for the first 1 MHz segment within range 2 400 MHz - BW to 2 400 MHz. Reduce the centre frequency in 1 MHz steps and repeat the measurements to cover this whole range. The centre frequency of the last 1 MHz segment shall be set to 2 400 MHz - BW + 0,5 MHz (which means this may partly overlap with the previous 1 MHz segment).

Step 5 (segment 2 400 MHz - 2BW to 2 400 MHz - BW):

- Change the centre frequency of the analyser to 2 399,5 MHz - BW and perform the measurement for the first 1 MHz segment within range 2 400 MHz - 2BW to 2 400 MHz - BW. Reduce the centre frequency in 1 MHz steps and repeat the measurements to cover this whole range. The centre frequency of the last 1 MHz segment shall be set to 2 400 MHz - 2BW + 0,5 MHz (which means this may partly overlap with the previous 1 MHz segment).

Step 6:

- In case of conducted measurements on equipment with a single transmit chain, the declared antenna assembly gain "G" in dBi shall be added to the results for each of the 1 MHz segments and compared with the limits provided by the mask given in figure 1 or figure 3. If more than one antenna assembly is intended for this power setting, the antenna with the highest gain shall be considered.
- In case of conducted measurements on smart antenna systems (equipment with multiple transmit chains), the measurements need to be repeated for each of the active transmit chains. The declared antenna assembly gain "G" in dBi for a single antenna shall be added to these results. If more than one antenna assembly is intended for this power setting, the antenna with the highest gain shall be considered. Comparison with the applicable limits shall be done using any of the options given below:
 - Option 1: the results for each of the transmit chains for the corresponding 1 MHz segments shall be added. The additional beamforming gain "Y" in dB shall be added as well and the resulting values compared with the limits provided by the mask given in figure 1 or figure 3.
 - Option 2: the limits provided by the mask given in figure 1 or figure 3 shall be reduced by

$10 \times \log_{10}(\text{Ach})$ and the additional beamforming gain "Y" in dB. The results for each of the transmit

chains shall be individually compared with these reduced limits.

NOTE: Ach refers to the number of active transmit chains.

It shall be recorded whether the equipment complies with the mask provided in figure 1 or figure 3.

■ Radiated measurement

The test set up as described in annex B and the applicable measurement procedures described in annex C shall be used. Alternatively a test fixture may be used.

The test procedure is as described under clause 5.4.8.2.1.

9.4.5 Test Results

PASS.

All the modulation modes were tested, the data of the worst mode are described in the following table



Transmitter Unwanted Emission In The Out-Of Band

- 802.11b 802.11g 802.11n(HT20) 802.11n(HT40)
 2412MHz 2422MHz 2462MHz 2472MHz

Test Freq (MHz)	Freq(MHz)	Level	Limit
2412	2397.500	-37.43	-10
2412	2386.308	-41.89	-20

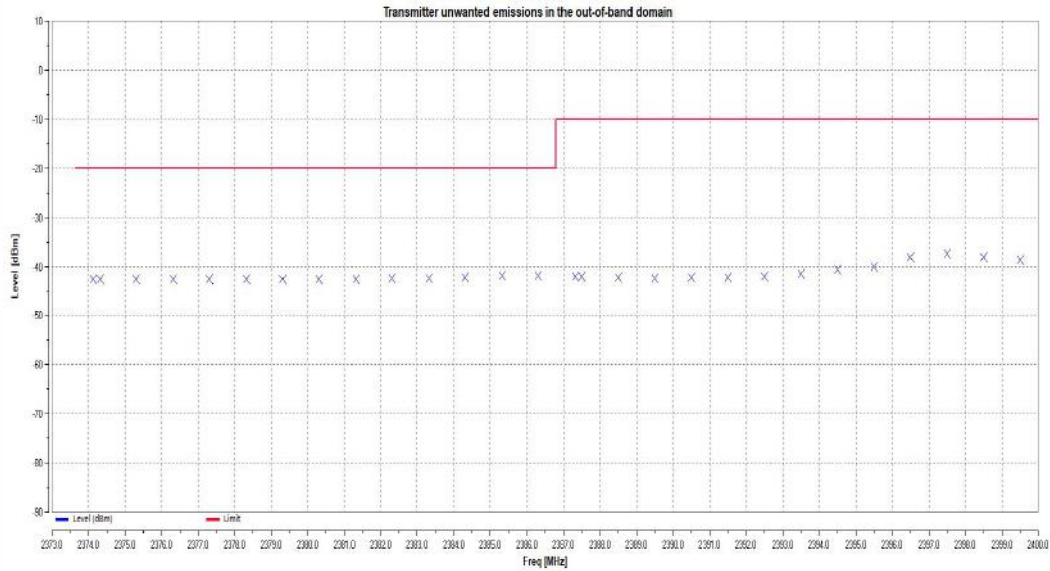

Transmitter Unwanted Emission In The Out-Of Band

- 802.11b 802.11g 802.11n(HT20) 802.11n(HT40)
 2412MHz 2422MHz 2462MHz 2472MHz

Test Freq (MHz)	Freq(MHz)	Level	Limit
2472	2485.000	-39.11	-10
2472	2498.151	-42.09	-20

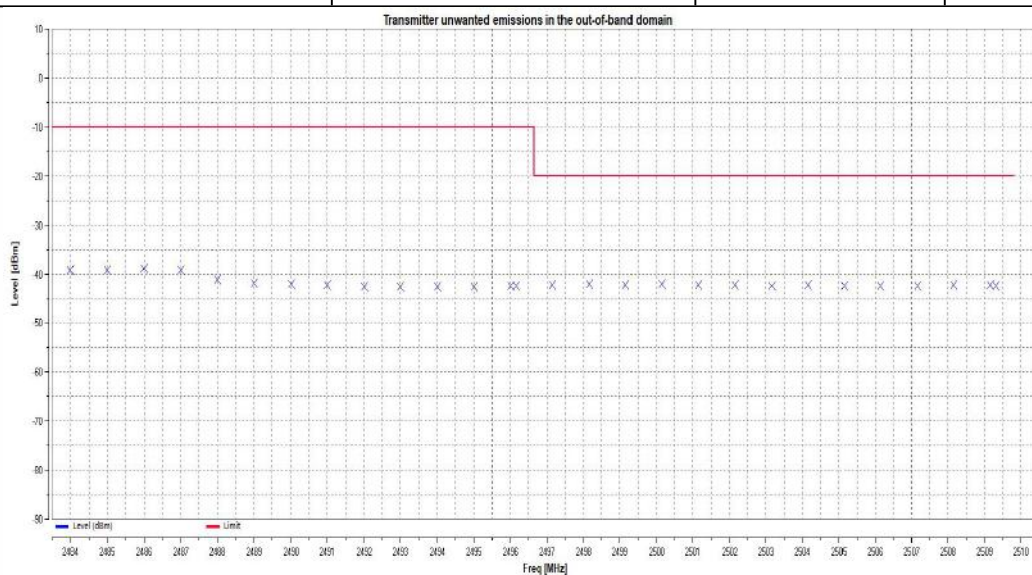

Transmitter Unwanted Emission In The Out-Of Band

- 802.11b 802.11g 802.11n(HT20) 802.11n(HT40)
 2412MHz 2422MHz 2462MHz 2472MHz

Test Freq (MHz)	Freq(MHz)	Level	Limit
2412	2399.500	-34.50	-10
2412	2382.894	-42.52	-20

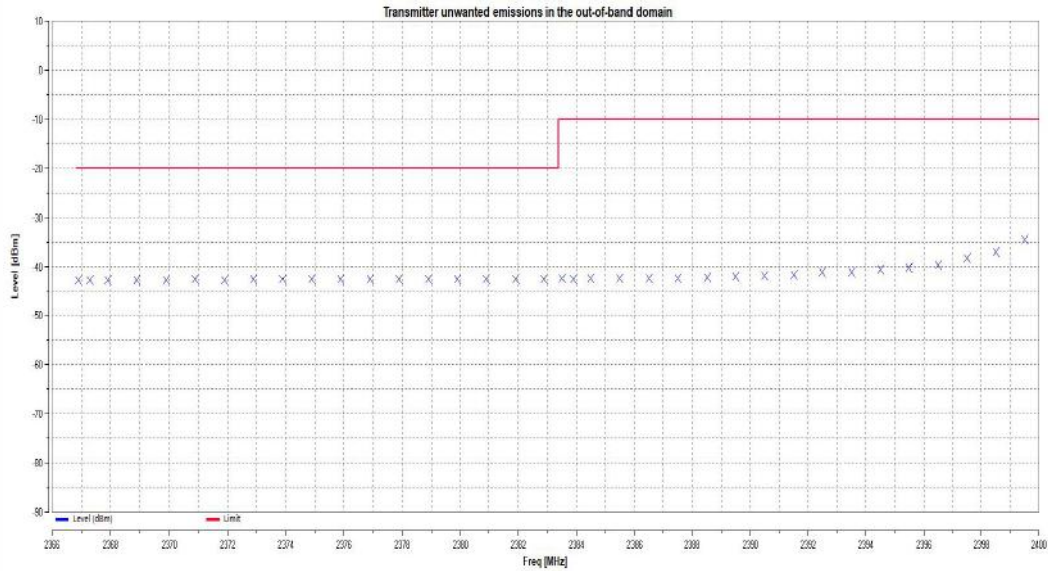

Transmitter Unwanted Emission In The Out-Of Band

- 802.11b 802.11g 802.11n(HT20) 802.11n(HT40)
 2412MHz 2422MHz 2462MHz 2472MHz

Test Freq (MHz)	Freq(MHz)	Level	Limit
2472	2484.000	-33.78	-10
2472	2500.597	-42.30	-20

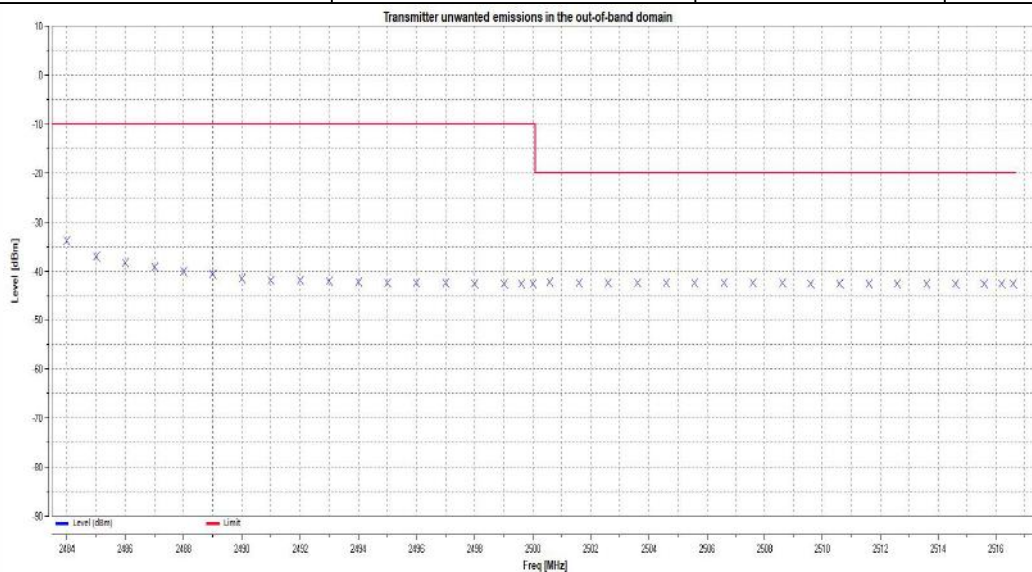

Transmitter Unwanted Emission In The Out-Of Band

- 802.11b 802.11g 802.11n(HT20) 802.11n(HT40)
 2412MHz 2422MHz 2462MHz 2472MHz

Test Freq (MHz)	Freq(MHz)	Level	Limit
2412	2399.500	-34.40	-10
2412	2381.949	-43.01	-20

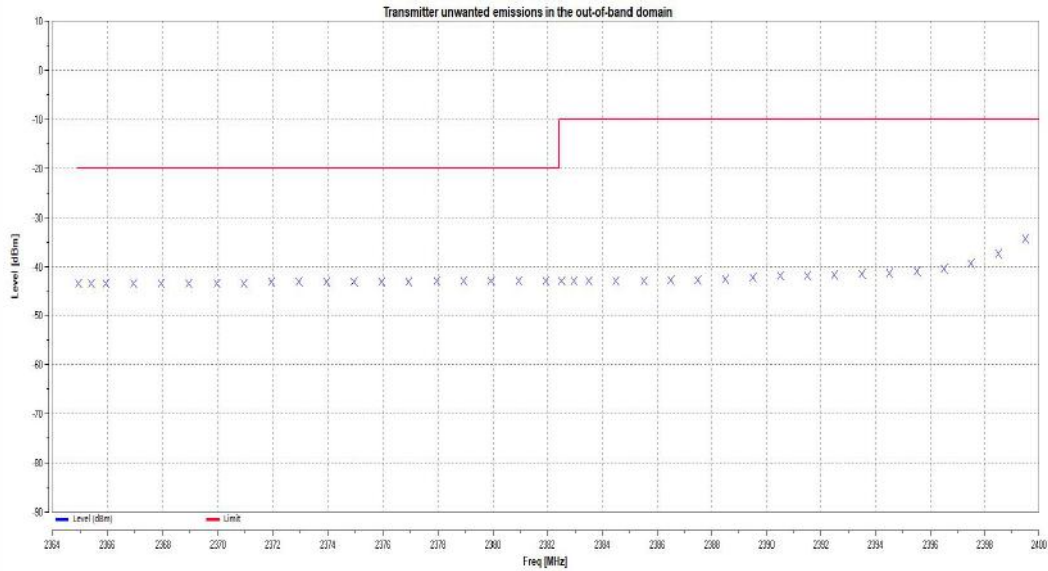

Transmitter Unwanted Emission In The Out-Of Band

- 802.11b 802.11g 802.11n(HT20) 802.11n(HT40)
 2412MHz 2422MHz 2462MHz 2472MHz

Test Freq (MHz)	Freq(MHz)	Level	Limit
2472	2484.000	-34.43	-10
2472	2503.534	-42.87	-20

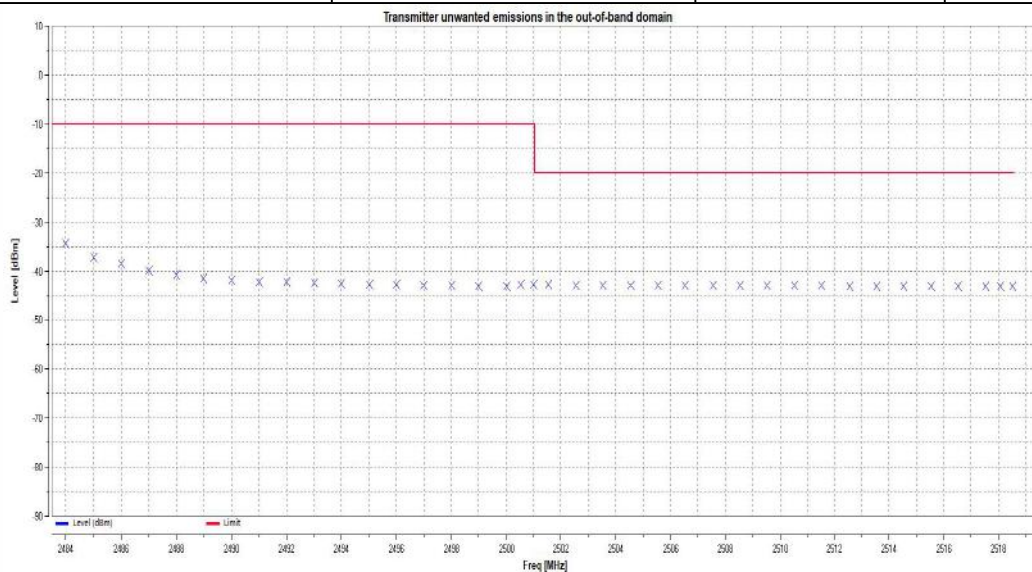

9.5 TRANSMITTER UNWANTED EMISSIONS IN THE SPURIOUS DOMAIN

9.5.1 Applicable standard

ETSI EN 300 328 clause 4.3.2.9

9.5.2 Conformance Limit

The transmitter unwanted emissions in the spurious domain shall not exceed the values given in below.

In case of equipment with antenna connectors, these limits apply to emissions at the antenna port (conducted). For emissions radiated by the cabinet or emissions radiated by integral antenna equipment (without antenna connectors), these limits are e.r.p. for emissions up to 1 GHz and as e.i.r.p. for emissions above 1 GHz.

Frequency Range	Maximum power	bandwidth
30 MHz to 47 MHz	-36dBm	100kHz
47 MHz to 74 MHz	-54dBm	100kHz
74 MHz to 87.5 MHz	-36dBm	100kHz
87.5MHz to118 MHz	-54dBm	100kHz
118 MHz to174MHz	-36dBm	100kHz
174MHz to 230MHz	-54dBm	100kHz
230 MHz to 470 MHz	-36dBm	100kHz
470 MHz to 694 MHz	-54dBm	100kHz
694 MHz to1 GHz	-36dBm	100kHz
1GHz to12.75 GHz	-30dBm	1MHz

9.5.3 Test Configuration

The measurements for emissions in the spurious domain shall only be performed at normal test conditions.

Radiated measurements shall be used for equipment.

Conducted measurements shall be used for equipment.

9.5.4 Test Procedure

1. Please refer to ETSI EN 300 328 (V2.2.2) clause 5.4.9.1 for the test conditions.
2. Please refer to ETSI EN 300 328 (V2.2.2) clause 5.4.9.2 for the measurement methods.

■ Conducted measurement

● Introduction

The spectrum in the spurious domain (see figure 1 or figure 3) shall be searched for emissions that exceed the limit values given in table 4 or table 12 or that come to within 6 dB below these limits. Each occurrence shall be recorded.

The measurement procedure contains 2 parts.

● Pre-scan

The test procedure below shall be used to identify potential unwanted emissions of the UUT.

Step 1:

The sensitivity of the measurement set-up should be such that the noise floor is at least 12 dB below the limits given in table 4 or table 12.

Step 2:

The emissions over the range 30 MHz to 1 000 MHz shall be identified.

Spectrum analyser settings:

- Resolution bandwidth: 100 kHz
- Video bandwidth: 300 kHz
- Filter type: 3 dB (Gaussian)
- Detector mode: Peak
- Trace Mode: Max Hold
- Sweep Points: $\geq 19\,400$; For spectrum analysers not supporting this high number of sweep points, the frequency band may need to be segmented.
- Sweep time: For non continuous transmissions (duty cycle less than 100 %), the sweep time shall be sufficiently long, such that for each 100 kHz frequency step, the measurement time is greater than two transmissions of the UUT, on any channel.

For Frequency Hopping equipment operating in a normal operating (hopping not disabled) mode, the sweep time shall be further increased to capture multiple transmissions on any of the hopping frequencies.

The above sweep time setting may result in long measuring times in case of frequency hopping equipment. To avoid such long measuring times, an FFT analyser could be used.

Allow the trace to stabilize. Any emissions identified during the sweeps above and that fall within the 6 dB range below the applicable limit or above, shall be individually measured using the procedure in clause 5.4.9.2.1.3 and compared to the limits given in table 4 or table 12.

Step 3:

The emissions over the range 1 GHz to 12,75 GHz shall be identified.

Spectrum analyser settings:

- Resolution bandwidth: 1 MHz
- Video bandwidth: 3 MHz
- Filter type: 3 dB (Gaussian)
- Detector mode: Peak
- Trace Mode: Max Hold
- Sweep Points: $\geq 23\,500$; For spectrum analysers not supporting this high number of sweep points, the frequency band may need to be segmented.
- Sweep time: For non continuous transmissions (duty cycle less than 100 %), the sweep time shall be sufficiently long, such that for each 1 MHz frequency step, the measurement time is greater than two transmissions of the UUT, on any channel.

For Frequency Hopping equipment operating in a normal operating (hopping not disabled) mode, the sweep time shall be further increased to capture multiple transmissions on any of the hopping frequencies.

The above sweep time setting may result in long measuring times in case of frequency hopping equipment. To avoid such long measuring times, an FFT analyser could be used.

Allow the trace to stabilize. Any emissions identified during the sweeps above that fall within the 6 dB range below the applicable limit or above, shall be individually measured using the procedure in clause 5.4.9.2.1.3 and compared to the limits given in table 4 or table 12.

Frequency Hopping equipment may generate a block (or several blocks) of spurious emissions anywhere within the spurious domain. If this is the case, only the highest peak of each block of emissions shall be measured using the procedure in clause 5.4.9.2.1.3.

Step 4:

- In case of conducted measurements on smart antenna systems (equipment with multiple transmit chains), step 2 and step 3 need to be repeated for each of the active transmit chains (Ach). The limits used to identify emissions during this pre-scan need to be reduced with $10 \times \log_{10}(\text{Ach})$ (number of active transmit chains).

- Measurement of the emissions identified during the pre-scan

The procedure in step 1 to step 4 below shall be used to accurately measure the individual unwanted emissions identified during the pre-scan measurements above. This method assumes

the spectrum analyser has a Time Domain Power function.

Step 1:

- Measurement Mode: Time Domain Power
- Centre Frequency: Frequency of the emission identified during the pre-scan
- Resolution Bandwidth: 100 kHz (< 1 GHz) / 1 MHz (> 1 GHz)
- Video Bandwidth: 300 kHz (< 1 GHz) / 3 MHz (> 1 GHz)
- Frequency Span: Zero Span
- Sweep mode: Single Sweep
- Sweep time: > 120 % of the duration of the longest burst detected during the measurement of the RF Output Power
- Sweep points: Sweep time [µs] / (1 µs) with a maximum of 30 000
- Trigger: Video (burst signals) or Manual (continuous signals)
- Detector: RMS

Step 2:

- Set a window where the start and stop indicators match the start and end of the burst with the highest level and record the value of the power measured within this window. If the spurious emission to be measured is a continuous transmission, the measurement window shall be set to match the start and stop times of the sweep.

Step 3:

In case of conducted measurements on smart antenna systems (equipment with multiple transmit chains), step 2 needs to be repeated for each of the active transmit chains (Ach).

Sum the measured power (within the observed window) for each of the active transmit chains.

Step 4:

The value defined in step 3 shall be compared to the limits defined in table 4 or table 12.

■ Radiated measurement

The test site as described in annex B and applicable measurement procedures as described in annex C shall be used.

The test procedure is further as described under clause 5.4.9.2.1.

9.5.5 Test Results

■ Radiated measurement

All the modulation modes were tested; the data of the worst mode are described in the following table

Emissions In the Spurious Domain below 1GHz.

Operation Mode: 802.11b 802.11g 802.11n(HT20) 802.11n(HT40)
 Operation frequency: 2412MHz Temperature: 24°C
 Humidity: 55 % RH Tested by: XSJ

Frequency (MHz)	Antenna Polarization		Emission level (dBm)	Limit (dBm)	Verdict
64.34	<input checked="" type="checkbox"/> V	<input type="checkbox"/> conducted	-67.78	-54.00	PASS
80.83			-64.67	-36.00	PASS
88.98			-67.84	-54.00	PASS
185.39			-69.06	-54.00	PASS
191.41			-68.50	-54.00	PASS
209.45			-72.27	-54.00	PASS
62.11	<input checked="" type="checkbox"/> H		-70.64	-54.00	PASS
64.34			-67.21	-54.00	PASS
66.57			-69.20	-54.00	PASS
90.43			-72.32	-54.00	PASS
183.36			-63.62	-54.00	PASS
191.41			-62.85	-54.00	PASS

Emissions In the Spurious Domain above 1GHz.

Operation Mode: 802.11b 802.11g 802.11n(HT20) 802.11n(HT40)
 Operation frequency: 2412MHz Temperature: 24°C
 Humidity: 55 % RH Tested by: XSJ

Frequency (MHz)	Antenna Polarization		Emission level (dBm)	Limit (dBm)	Verdict
4491.00	<input checked="" type="checkbox"/> V	<input type="checkbox"/> conducted	-51.76	-30.00	PASS
4944.00			-52.16	-30.00	PASS
5999.50			-50.03	-30.00	PASS
6655.50			-48.93	-30.00	PASS
7898.00			-46.22	-30.00	PASS
9888.00			-43.36	-30.00	PASS
3932.00	<input checked="" type="checkbox"/> H		-54.19	-30.00	PASS
4944.00			-48.42	-30.00	PASS
7191.00			-47.19	-30.00	PASS
7917.50			-46.27	-30.00	PASS
9888.00			-44.07	-30.00	PASS
13414.00			-43.14	-30.00	PASS

■ Conducted measurement

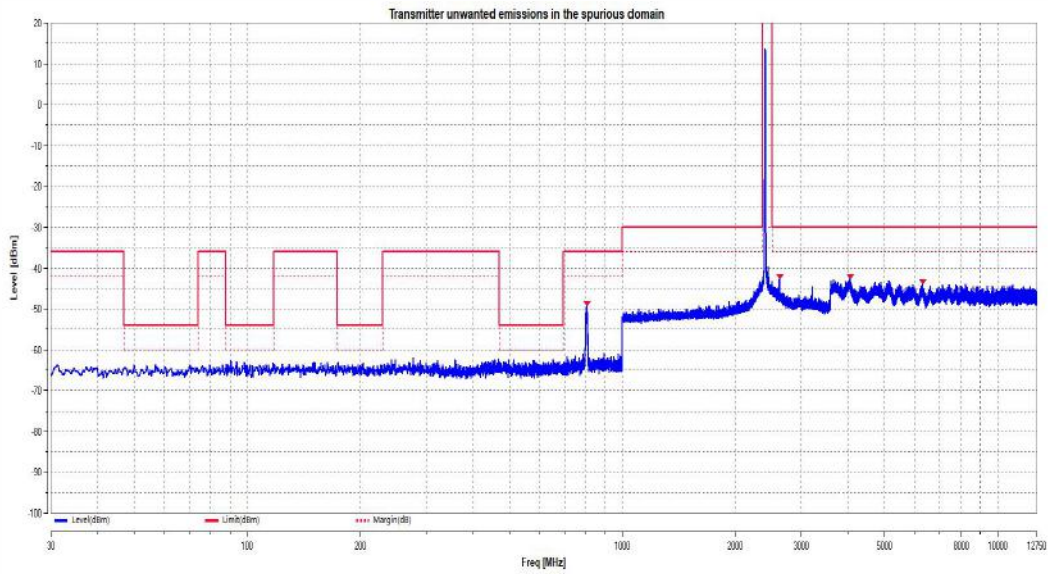

9.6 RECEIVER SPURIOUS EMISSIONS

9.6.1 Applicable standard

ETSI EN 300 328 clause 4.3.2.10

9.6.2 Conformance Limit

The spurious emissions of the receiver shall not exceed the values given in below.

In case of equipment with antenna connectors, these limits apply to emissions at the antenna port (conducted). For emissions radiated by the cabinet or emissions radiated by integral antenna equipment (without antenna connectors), these limits are e.r.p. for emissions up to 1 GHz and e.i.r.p. for emissions above 1 GHz.

Frequency Range	Maximum power	Measurement Width
30 MHz to 1 GHz	-57 dBm	100kHz
1 GHz to 12.75 GHz	-47 dBm	1MHz

9.6.3 Test Configuration

The measurements for emissions in the spurious domain shall only be performed at normal test conditions.

Radiated measurements shall be used for equipment.

Conducted measurements shall be used for equipment.

9.6.4 Test Procedure

1. Please refer to ETSI EN 300 328 (V2.2.2) clause 5.4.11.1 for the test conditions.
2. Please refer to ETSI EN 300 328 (V2.2.2) clause 5.4.11.2 for the measurement methods.

■ Conducted measurement

● Introduction

The spectrum in the spurious domain (see figure 1 or figure 3) shall be searched for emissions that exceed the limit values given in table 4 or table 12 or that come to within 6 dB below these limits. Each occurrence shall be recorded.

The measurement procedure contains 2 parts.

● Pre-scan

The test procedure below shall be used to identify potential unwanted emissions of the UUT.

Step 1:

The sensitivity of the spectrum analyser should be such that the noise floor is at least 12 dB below the limits given in table 5 or table 13.

Step 2:

The emissions over the range 30 MHz to 1 000 MHz shall be identified.

Spectrum analyser settings:

- Resolution bandwidth: 100 kHz
- Video bandwidth: 300 kHz
- Filter type: 3 dB (Gaussian)
- Detector mode: Peak
- Trace Mode: Max Hold
- Sweep Points: $\geq 19\ 400$;
- Sweep time: Auto

Wait for the trace to stabilize. Any emissions identified during the sweeps above and that fall within

the 6 dB range below the applicable limit or above, shall be individually measured using the procedure in clause 5.4.10.2.1.3 and compared to the limits given in table 5 or table 13.

Step 3:

The emissions over the range 1 GHz to 12,75 GHz shall be identified.

Spectrum analyser settings:

- Resolution bandwidth: 1 MHz
- Video bandwidth: 3 MHz
- Filter type: 3 dB (Gaussian)
- Detector mode: Peak
- Trace Mode: Max Hold
- Sweep Points: $\geq 23\ 500$; For spectrum analysers not supporting this high number of sweep points, the frequency band may need to be segmented.
- Sweep time: Auto

Wait for the trace to stabilize. Any emissions identified during the sweeps above that fall within the 6 dB range below the applicable limit or above, shall be individually measured using the procedure in clause 5.4.10.2.1.3 and compared to the limits given in table 5 or table 13.

FHSS equipment may generate a block (or several blocks) of spurious emissions anywhere within the spurious domain. If this is the case, only the highest peak of each block of emissions shall be measured using the procedure in clause 5.4.10.2.1.3.

Step 4:

- In case of conducted measurements on smart antenna systems (equipment with multiple transmit chains), step 2 and step 3 need to be repeated for each of the active transmit chains (Ach). The limits used to identify emissions during this pre-scan need to be reduced with $10 \times \log_{10}(\text{Ach})$ (number of active transmit chains).

● Measurement of the emissions identified during the pre-scan

The procedure in step 1 to step 4 below shall be used to accurately measure the individual unwanted emissions identified during the pre-scan measurements above. This method assumes the spectrum analyser has a Time Domain Power function.

Step 1:

The level of the emissions shall be measured using the following spectrum analyser settings:

- Measurement Mode: Time Domain Power
- Centre Frequency: Frequency of the emission identified during the pre-scan
- Resolution Bandwidth: 100 kHz (< 1 GHz) / 1 MHz (> 1 GHz)
- Video Bandwidth: 300 kHz (< 1 GHz) / 3 MHz (> 1 GHz)
- Frequency Span: Zero Span
- Sweep mode: Single Sweep
- Sweep time: 30ms
- Sweep points: $\geq 30\ 000$
- Trigger: Video (burst signals) or Manual (continuous signals)
- Detector: RMS

Step 2:

- Set a window where the start and stop indicators match the start and end of the burst with the highest level and record the value of the power measured within this window. If the spurious emission to be measured is a continuous transmission, the measurement window shall be set to match the start and stop times of the sweep.

Step 3:

In case of conducted measurements on smart antenna systems (equipment with multiple transmit chains), step 2 needs to be repeated for each of the active transmit chains (Ach).

Sum the measured power (within the observed window) for each of the active transmit chains.

Step 4:

The value defined in step 3 shall be compared to the limits defined in table 4 or table 12.

■ Radiated measurement

The test site as described in annex B and applicable measurement procedures as described in annex C shall be used.

The test procedure is further as described under clause 5.4.9.2.1.

9.6.5 Test Results

■ Radiated measurement

All the modulation modes were tested, the data of the worst mode are described in the following table

Emissions In the Spurious Domain below 1GHz.

Operation Mode:	<input checked="" type="checkbox"/> 802.11b	<input type="checkbox"/> 802.11g	<input type="checkbox"/> 802.11n(HT20)	<input type="checkbox"/> 802.11n(HT40)
Operation frequency:	<input checked="" type="checkbox"/> 2472MHz	Temperature: 24°C		
Humidity:	55 % RH		Tested by:	XSJ

Frequency (MHz)	Antenna Polarization		Emission level (dBm)	Limit (dBm)	Verdict
64.24	<input checked="" type="checkbox"/> V	<input type="checkbox"/> conducted	-67.88	-57.00	PASS
66.57			-69.85	-57.00	PASS
79.96			-67.01	-57.00	PASS
82.96			-66.99	-57.00	PASS
143.49			-71.04	-57.00	PASS
203.44			-72.36	-57.00	PASS
65.02	<input checked="" type="checkbox"/> H		-68.51	-57.00	PASS
77.72			-72.50	-57.00	PASS
142.71			-66.91	-57.00	PASS
191.41			-72.45	-57.00	PASS
299.37			-70.60	-57.00	PASS
323.13			-70.00	-57.00	PASS

Emissions In the Spurious Domain above 1GHz.

Operation Mode:	<input checked="" type="checkbox"/> 802.11b	<input type="checkbox"/> 802.11g	<input type="checkbox"/> 802.11n(HT20)	<input type="checkbox"/> 802.11n(HT40)
Operation frequency:	<input checked="" type="checkbox"/> 2472MHz	Temperature: 24°C		
Humidity:	55 % RH		Tested by:	XSJ

Frequency (MHz)	Antenna Polarization		Emission level (dBm)	Limit (dBm)	Verdict
1625.40	<input checked="" type="checkbox"/> V	<input type="checkbox"/> conducted	-57.20	-47.00	PASS
3260.50			-56.22	-47.00	PASS
3492.00			-56.22	-47.00	PASS
3771.00			-55.20	-47.00	PASS
4212.00			-54.90	-47.00	PASS
5372.50			-54.79	-47.00	PASS
1829.00	<input checked="" type="checkbox"/> H		-59.98	-47.00	PASS
3112.00			-57.64	-47.00	PASS
3307.50			-56.43	-47.00	PASS
3762.00			-56.41	-47.00	PASS
4595.50			-54.96	-47.00	PASS
5370.50			-54.13	-47.00	PASS

■ Conducted measurement

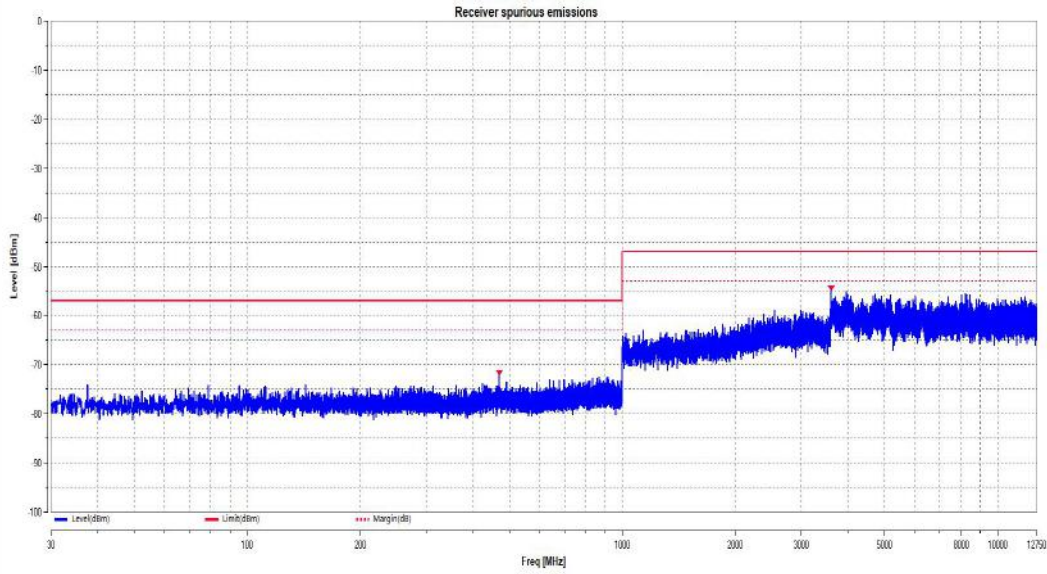

9.7 Adaptivity (adaptive equipment using modulations other than FHSS)

9.7.1 Applicable standard

ETSI EN 300 328 clause 4.3.2.6

9.7.2 Conformance Limit

Only for adaptive equipment and RF output power ≥ 10 dBm(ERP)

■ For LBT based Detect and avoid equipment shall comply with the following requirement
Load Based Equipment may implement an LBT based spectrum sharing mechanism based on the Clear Channel

Assessment (CCA) mode using energy detect as described in IEEE 802.11™-2012 [i.3], clause 9, clause 10, clause 16, clause 17, clause 19 and clause 20, or in IEEE 802.15.4™-2011 [i.4], clause 4, clause 5 and clause 8 providing the equipment complies with the conformance requirements referred to in clause 4.3.2.6.3.4. Load Based Equipment not using any of the mechanisms referenced above shall comply with the following minimum set of requirements:

1) Before a transmission or a burst of transmissions, the equipment shall perform a Clear Channel Assessment (CCA) check using energy detect. The equipment shall observe the operating channel for the duration of the CCA observation time which shall be not less than 18 μ s. The channel shall be considered occupied if the energy level in the channel exceeds the threshold given in step 5 below. If the equipment finds the channel to be clear, it may transmit immediately.

2) If the equipment finds the channel occupied, it shall not transmit on this channel (see also the next paragraph). The equipment shall perform an Extended CCA check in which the channel is observed for a random duration in the range between 18 μ s and at least 160 μ s. If the extended CCA check has determined the channel to be no longer occupied, the equipment may resume transmissions on this channel. If the Extended CCA time has determined the channel still to be occupied, it shall perform new Extended CCA checks until the channel is no longer occupied.

NOTE: The Idle Period in between transmissions is considered to be the CCA or the Extended CCA check as there are no transmissions during this period.

The equipment is allowed to switch to a non-adaptive mode and to continue transmissions on this channel providing it complies with the requirements applicable to non-adaptive equipment.

Alternatively, the equipment is also allowed to continue Short Control Signalling Transmissions on this channel providing it complies with the requirements given in clause 4.3.2.6.4.

3) The total time that an equipment makes use of a RF channel is defined as the Channel Occupancy Time. This Channel Occupancy Time shall be less than 13 ms, after which the device shall perform a new CCA as described in step 1 above.

4) The equipment, upon correct reception of a packet which was intended for this equipment can skip CCA and immediately (see also next paragraph) proceed with the transmission of management and control frames (e.g. ACK and Block ACK frames are allowed but data frames are not allowed). A consecutive sequence of transmissions by the equipment without a new CCA shall not exceed the maximum channel occupancy time as defined in step 3 above.

For the purpose of multi-cast, the ACK transmissions (associated with the same data packet) of the individual devices are allowed to take place in a sequence.

5) The energy detection threshold for the CCA shall be proportional to the transmit power of the transmitter: for a 20 dBm e.i.r.p. transmitter the CCA threshold level (TL) shall be equal to or less than -70 dBm/MHz at the input to the receiver assuming a 0 dBi (receive) antenna assembly. This threshold level (TL) may be corrected for the (receive) antenna assembly gain (G); however, beamforming gain (Y) shall not be taken into account. For power levels less than 20 dBm e.i.r.p., the CCA threshold level may be relaxed to:

$TL = -70 \text{ dBm/MHz} + 10 \times \log_{10} (100 \text{ mW} / P_{out})$ (P_{out} in mW e.i.r.p.)

6) The equipment shall comply with the requirements defined in step 1 to step 4 of the present clause in the presence of an unwanted CW signal as defined in below.

Unwanted Signal parameters

Wanted signal mean power from companion device	Unwanted signal frequency (MHz)	Unwanted signal power (dBm)
sufficient to maintain the link (see note 2)	2 395 or 2 488,5 (see note 1)	-35 (see note 3)

NOTE 1: The highest frequency shall be used for testing operating channels within the range 2 400 MHz to 2 442 MHz, while the lowest frequency shall be used for testing operating channels within the range 2 442 MHz to 2 483,5 MHz. See clause 5.4.6.1.
 NOTE 2: A typical value which can be used in most cases is -50 dBm/MHz.
 NOTE 3: The level specified is the level at the UUT receiver input assuming a 0 dBi antenna assembly gain. In case of conducted measurements, this level has to be corrected for the (in-band) antenna assembly gain (G). In case of radiated measurements, this level is equivalent to a power flux density (PFD) in front of the UUT antenna.

■ Short control signaling transmissions

If implemented, Short Control Signalling Transmissions of adaptive equipment using wide band modulations other than FHSS shall have a maximum TxOn / (TxOn + TxOff) ratio of 10 % within any observation period of 50 ms.

9.7.3 Test Configuration

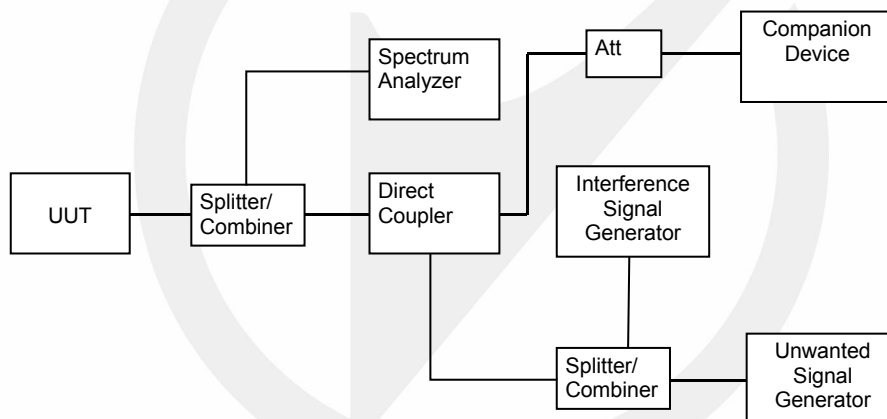

9.7.4 Test Procedure

1. Please refer to ETSI EN 300 328 (V2.2.2) clause 5.4.6.1 for the test conditions.
2. Please refer to ETSI EN 300 328 (V2.2.2) clause 5.4.6.2 for the measurement method.

Step 1 to step 7 below define the procedure to verify the efficiency of the DAA or LBT based adaptive mechanisms for FHSS equipment. These mechanisms are described in clause 4.3.1.7.

For systems using multiple receive chains only one chain (antenna port) need to be tested. All other receiver inputs shall be terminated.

Step 1:

- The UUT shall connect to a companion device during the test. The interference signal generator, the unwanted signal generator, the spectrum analyser, the UUT and the companion device are connected using a set-up equivalent to the example given by figure 5, although the interference and unwanted signal generators do not generate any signals at this point in time. The spectrum analyser is used to monitor the transmissions of both the UUT and the companion device and it should be possible to distinguish between either transmissions. In addition, the spectrum analyser is used to monitor the transmissions of the UUT in response to the interfering and the unwanted signals.
- For the hopping frequency to be tested, adjust the received signal level (wanted signal from the

companion device) at the UUT to the value defined in table 2 and table 3 (clause 4).

Testing of Unidirectional equipment does not require a link to be established with a companion device.

• The analyser shall be set as follows:

- RBW: Use next available RBW setting below the measured Occupied Channel Bandwidth
- Filter type: Channel Filter
- VBW: \geq RBW
- Detector Mode: RMS
- Centre Frequency: Equal to the hopping frequency to be tested
- Span: 0 Hz
- Sweep time: >Channel Occupancy Time of the UUT. If the Channel Occupancy Time is non-contiguous (DAA based equipment), the sweep time shall be sufficient to cover the period over which the Channel Occupancy Time is spread out
- Trace Mode: Clear Write
- Trigger Mode: Video

Step 2:

- Configure the UUT for normal transmissions with a sufficiently high payload resulting in a minimum transmitter activity ratio (TxOn / (TxOn + TxOff)) of 0,3. Where this is not possible, the UUT shall be configured to the maximum payload possible.
- Using the procedure defined in clause 5.4.6.2.1.5, it shall be verified that, for equipment with a dwell time greater than the maximum allowable Channel Occupancy Time, the UUT complies with the maximum Channel Occupancy Time and minimum Idle Period defined in clause 4.3.1.7.2.2 or clause 4.3.1.7.3.2. When measuring the Idle Period of the UUT, only transmissions from the UUT shall be considered.

Step 3: Adding the interference signal

- An interference signal as defined in clause B.7 is injected centred on the hopping frequency being tested. The power spectral density level (at the input of the UUT) of this interference signal shall be equal to the detection threshold defined in clause 4.3.1.7.2.2 or clause 4.3.1.7.3.2.

Step 4: Verification of reaction to the interference signal

- The spectrum analyser shall be used to monitor the transmissions of the UUT on the selected operating channel with the interfering signal injected. This may require the spectrum analyser sweep to be triggered by the start of the interfering signal.
- Using the procedure defined in clause 5.4.6.2.1.5, it shall be verified that:
 - i) The UUT shall stop transmissions on the hopping frequency being tested. The UUT is assumed to stop transmissions on this hopping frequency within a period equal to the maximum Channel Occupancy Time defined in clause 4.3.1.7.2.2 or clause 4.3.1.7.3.2. As stated in clause 4.3.1.7.3.2, step 3, the Channel Occupancy Time for DAA based FHSS equipment may be noncontiguous.
 - ii) For LBT based FHSS equipment, apart from Short Control Signalling Transmissions (see iii) below), there shall be no subsequent transmissions on this hopping frequency, as long as the interference signal remains present.
 - iii) For DAA based FHSS equipment, apart from Short Control Signalling Transmissions (see iii) below), there shall be no subsequent transmissions on this hopping frequency for a silent period defined in clause 4.3.1.7.3.2, step 2. After that, the UUT may have normal transmissions again for the duration of a single Channel Occupancy Time period (which may be non-contiguous). Because the interference signal is still present, another silent period as defined in clause 4.3.1.7.3.2, step 2 needs to be included. This sequence is repeated as long as the interfering signal is present.

In case of overlapping channels, transmissions in adjacent channels may generate transmission bursts on the channel being investigated; however, they have a lower amplitude as on-channel transmissions. Care should be taken to only evaluate the on-channel transmissions. The Time Domain Power Option of the analyser may be used to measure the RMS power of the individual bursts to distinguish on-channel transmissions from transmissions on adjacent channels. In some cases, the RBW may need to be reduced.

To verify that the UUT is not resuming normal transmissions as long as the interference signal is

present, the monitoring time may need to be 60 s or more. If transmissions are detected during this period, the settings of the analyser may need to be adjusted to allow an accurate assessment to verify the transmissions comply with the limits for Short Control Signalling Transmissions.

iii) The UUT may continue to have Short Control Signalling Transmissions on the hopping frequency being tested while the interference signal is present. These transmissions shall comply with the limits defined in clause 4.3.1.7.4.2.

The verification of the Short Control Signalling transmissions may require the analyser settings to be changed (e.g. sweep time).

iv) Alternatively, the equipment may switch to a non-adaptive mode.

Step 5: Adding the unwanted signal

- With the interfering signal present, a 100 % duty cycle CW signal is inserted as the unwanted signal. The

frequency and the level are provided in table 10 (clause 4.3.2.6.3.2.2) for Frame Based Equipment or in

table 11 (clause 4.3.2.6.3.2.3) for Load Based Equipment.

- The spectrum analyser shall be used to monitor the transmissions of the UUT on the selected operating

channel. This may require the spectrum analyser sweep to be triggered by the start of the unwanted signal.

- Using the procedure defined in clause 5.4.6.2.1.5, it shall be verified that:

i) The UUT shall not resume normal transmissions on the current operating channel as long as both the

interference and unwanted signals remain present.

To verify that the UUT is not resuming normal transmissions as long as the interference and unwanted

signals are present, the monitoring time may need to be 60 s or more.

ii) The UUT may continue to have Short Control Signalling Transmissions on the operating channel while

the interfering and unwanted signals are present. These transmissions shall comply with the limits defined in clause 4.3.2.6.4.2.

The verification of the Short Control Signalling transmissions may require the analyser settings to be

changed (e.g. sweep time).

Step 6: Removing the interference and unwanted signal

- On removal of the interference and unwanted signals the UUT is allowed to start transmissions again on this channel; however, this is not a requirement and, therefore, does not require testing.

Step 7:

- Step 2 to step 6 shall be repeated for each of the frequencies to be tested.

9.7.5 Test Results

All of the modes were tested the data of the worst mode are recorded in the following pages.

All of the modes were tested the data of the worst mode are recorded in the following pages.

Clear Channel Assessment (CCA) time

MODULATION MODE	DATA RATE	NOMINAL BANDWIDTH	TEST FREQUENCY	CCA (us)	LIMIT (us)	TEST RESULT
802.11b	1Mbps	20MHz	2412	129.33	18~160	PASS
			2472	127.89	18~160	PASS
802.11g	6Mbps	20MHz	2412	125.32	18~160	PASS
			2472	124.21	18~160	PASS
802.11n(HT20)	MCS0	20MHz	2412	125.33	18~160	PASS
			2472	123.44	18~160	PASS
802.11n(HT40)	MCS0	40MHz	2422	124.56	18~160	PASS
			2462	123.38	18~160	PASS
<input type="checkbox"/> Pout<=10dBm						N/A
NOTE: 1. N/A means not applicable						

Channel Occupancy Time (C.O.T)

MODULATION MODE	DATA RATE	NOMINAL BANDWIDTH	TEST FREQUENCY	C.O.T (ms)	LIMIT (ms)	TEST RESULT
802.11b	1Mbps	20MHz	2412	2.904	<13	PASS
			2472	2.887	<13	PASS
802.11g	6Mbps	20MHz	2412	1.679	<13	PASS
			2472	1.814	<13	PASS
802.11n(HT20)	MCS0	20MHz	2412	1.886	<13	PASS
			2472	1.987	<13	PASS
802.11n(HT40)	MCS0	40MHz	2422	1.804	<13	PASS
			2462	1.789	<13	PASS
<input type="checkbox"/> Pout<=10dBm						N/A
NOTE: 1.N/A means not applicable						

Short Control Signalling Transmission (S.C.S.T)

MODULATION MODE	DATA RATE	NOMINAL BANDWIDTH	TEST FREQUENCY	S.C.S.T	LIMIT	TEST RESULT
802.11b	1Mbps	20MHz	2412	0.0%	<10%	PASS
			2472	0.0%	<10%	PASS
802.11g	6Mbps	20MHz	2412	0.0%	<10%	PASS
			2472	0.0%	<10%	PASS
802.11n(HT20)	MCS0	20MHz	2412	0.0%	<10%	PASS
			2472	0.0%	<10%	PASS
802.11n(HT40)	MCS0	40MHz	2422	0.0%	<10%	PASS
			2462	0.0%	<10%	PASS
<input type="checkbox"/> Pout<=10dBm						N/A
S.C.S.T: means short control signalling transmission						
NOTE: N/A means not applicable						

CCA threshold level

MODULATION MODE	DATA RATE	TEST FREQUENCY	Output Power (dBm)	CCA level (dBm)	CCA threshold (dBm)	TEST RESULT	
802.11b	1Mbps	2412	17.83	-67.83	-70 dBm/MHz + 10 × log ₁₀ (100 mW / Pout) (Pout in mW e.i.r.p.)	PASS	
		2472	17.94	-67.94		PASS	
802.11g	6Mbps	2412	12.59	-62.59		PASS	
		2472	13.12	-63.12		PASS	
802.11n(HT20)	MCS0	2412	13.21	-63.21		PASS	
		2472	12.76	-62.76		PASS	
<input type="checkbox"/> Pout≤10dBm						N/A	
NOTE: N/A means not applicable CCA threshold = -70 dBm/MHz + 10 × log ₁₀ (100 mW / Pout) (Pout in mW e.i.r.p.)							

The data of the worst mode are described in the following pages



Adaptivity (adaptive equipment using modulations other than FHSS)

- | | | | |
|---|----------------------------------|--|--|
| <input checked="" type="checkbox"/> 802.11b | <input type="checkbox"/> 802.11g | <input type="checkbox"/> 802.11n(HT20) | <input type="checkbox"/> 802.11n(HT40) |
| <input checked="" type="checkbox"/> 2412MHz | <input type="checkbox"/> 2422MHz | <input type="checkbox"/> 2462MHz | <input type="checkbox"/> 2472MHz |

CCA Time (us)	125.56
Max COT (ms)	2.841
Interference Start Time (ms)	3000.00
Block Signal Start Time (ms)	63000.00
Transmission Time (ms)	0
SCST TxOn / (TxOn + TxOff) (%)	0
Pulse Width within 50ms (ms)	0

Channel Occupancy Time

- | | | | |
|---|----------------------------------|--|--|
| <input checked="" type="checkbox"/> 802.11b | <input type="checkbox"/> 802.11g | <input type="checkbox"/> 802.11n(HT20) | <input type="checkbox"/> 802.11n(HT40) |
| <input checked="" type="checkbox"/> 2412MHz | <input type="checkbox"/> 2422MHz | <input type="checkbox"/> 2462MHz | <input type="checkbox"/> 2472MHz |

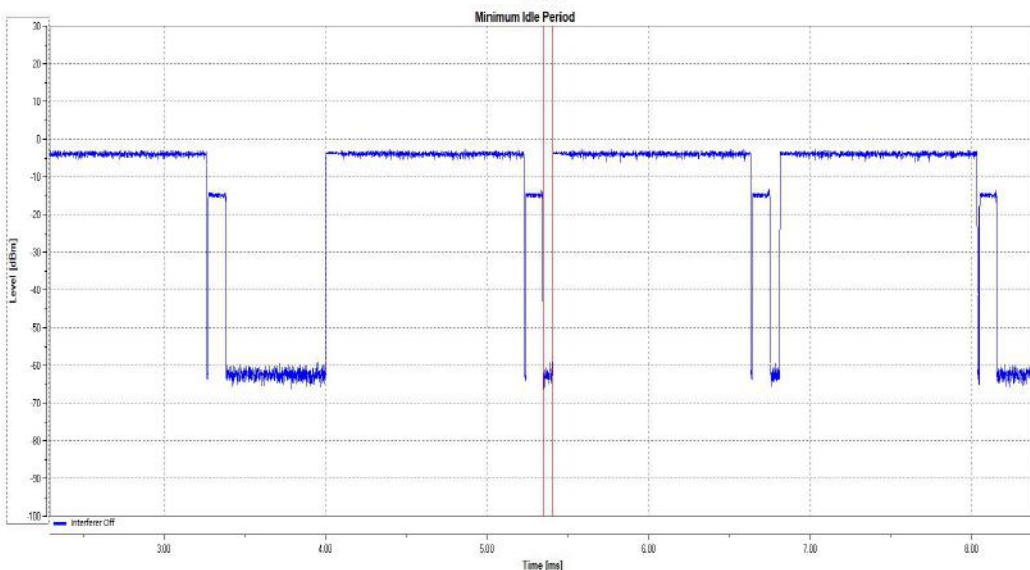
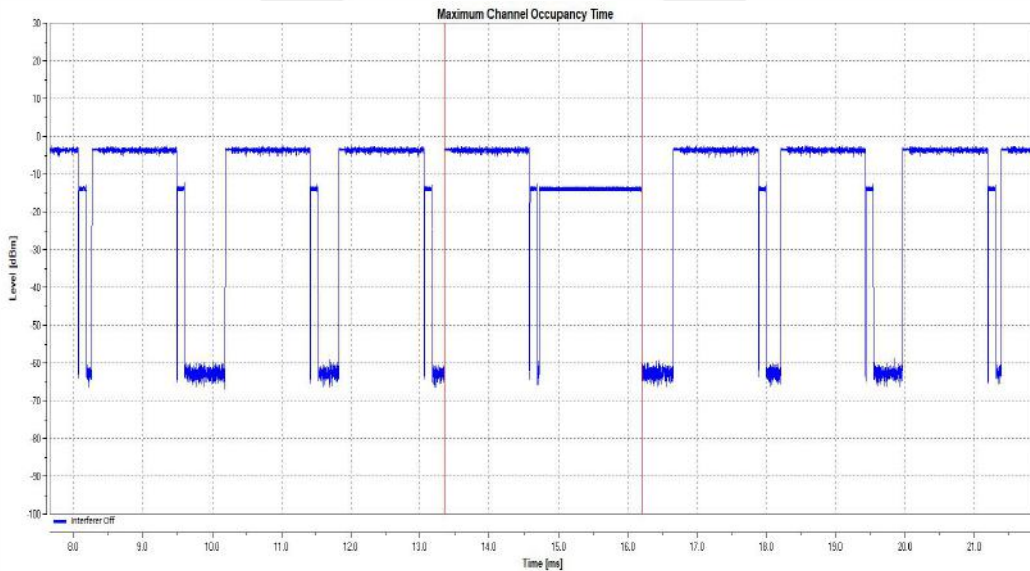

Adaptivity

- | | | | |
|---|----------------------------------|--|--|
| <input checked="" type="checkbox"/> 802.11b | <input type="checkbox"/> 802.11g | <input type="checkbox"/> 802.11n(HT20) | <input type="checkbox"/> 802.11n(HT40) |
| <input checked="" type="checkbox"/> 2412MHz | <input type="checkbox"/> 2422MHz | <input type="checkbox"/> 2462MHz | <input type="checkbox"/> 2472MHz |

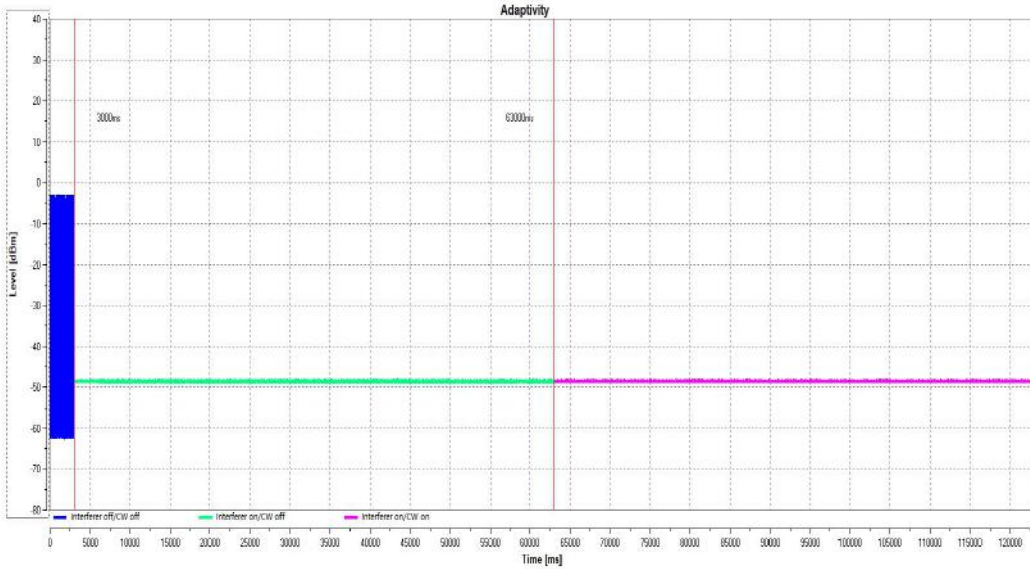

Short Control Signalling Transmissions

- | | | | |
|---|----------------------------------|--|--|
| <input checked="" type="checkbox"/> 802.11b | <input type="checkbox"/> 802.11g | <input type="checkbox"/> 802.11n(HT20) | <input type="checkbox"/> 802.11n(HT40) |
| <input checked="" type="checkbox"/> 2412MHz | <input type="checkbox"/> 2422MHz | <input type="checkbox"/> 2462MHz | <input type="checkbox"/> 2472MHz |

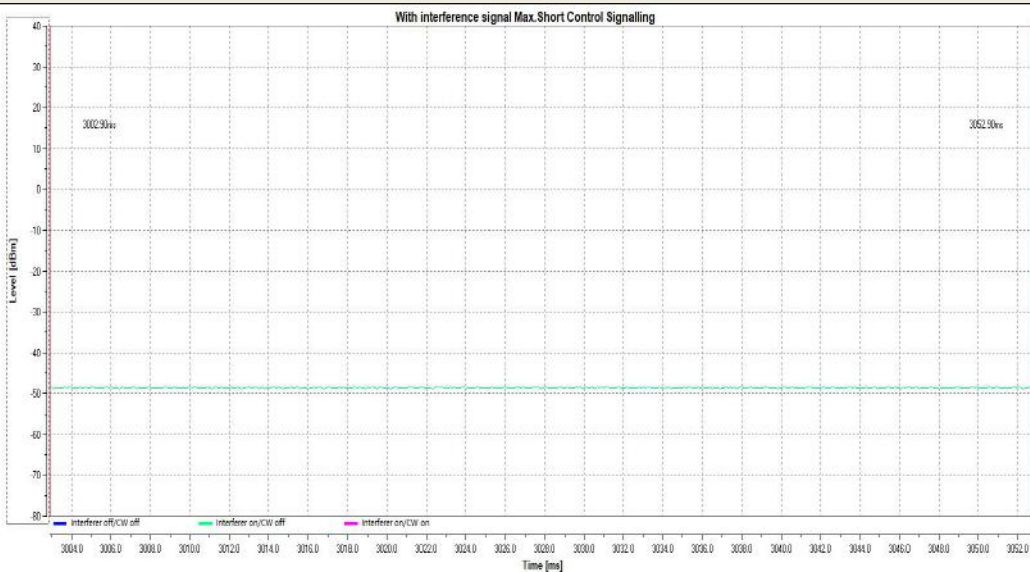

9.8 Receiver Blocking

9.8.1 Applicable standard

ETSI EN 300 328 clause 4.3.2.11

9.8.2 Conformance Limit

For equipment that supports a PER or FER test to be performed, the minimum performance criterion shall be a PER or FER less than or equal to 10 %.

For equipment that does not support a PER or a FER test to be performed, the minimum performance criterion shall be no loss of the wireless transmission function needed for the intended use of the equipment

■ General

While maintaining the minimum performance criteria as defined in clause 4.3.2.11.3, the blocking levels at specified frequency offsets shall be equal to or greater than the limits defined for the applicable receiver category provided in below.

● Receiver Category 1

Receiver Blocking parameters for Receiver Category 1 equipment

Wanted signal mean power from companion device (dBm)	Blocking signal frequency (MHz)	Blocking signal power (dBm) (see note 4)	Type of blocking signal
$(-133 \text{ dBm} + 10 \times \log_{10}(\text{OCBW}))$ or -68 dBm whichever is less (see note 2)	2 380 2 503,5	-34	CW
$(-139 \text{ dBm} + 10 \times \log_{10}(\text{OCBW}))$ or -74 dBm whichever is less (see note 3)	2 300 2 330 2 360 2 524 2 584 2 674	-34	CW

NOTE 1: OCBW is in Hz.

NOTE 2: In case of radiated measurements using a companion device and the level of the wanted signal from the companion device cannot be determined, a relative test may be performed using a wanted signal up to $P_{\text{min}} + 26 \text{ dB}$ where P_{min} is the minimum level of wanted signal required to meet the minimum performance criteria as defined in clause 4.3.1.12.3 in the absence of any blocking signal.

NOTE 3: In case of radiated measurements using a companion device and the level of the wanted signal from the companion device cannot be determined, a relative test may be performed using a wanted signal up to $P_{\text{min}} + 20 \text{ dB}$ where P_{min} is the minimum level of wanted signal required to meet the minimum performance criteria as defined in clause 4.3.1.12.3 in the absence of any blocking signal.

NOTE 4: The level specified is the level at the UUT receiver input assuming a 0 dBi antenna assembly gain. In case of conducted measurements, this level has to be corrected for the (in-band) antenna assembly gain (G). In case of radiated measurements, this level is equivalent to a power flux density (PFD) in front of the UUT antenna with the UUT being configured/positioned as recorded in clause 5.4.3.2.2.

●Receiver Category 2

Receiver Blocking parameters receiver category 2 equipment

Wanted signal mean power from companion device (dBm)	Blocking signal frequency (MHz)	Blocking signal power (dBm) (see note 3)	Type of blocking signal
$(-139 \text{ dBm} + 10 \times \log_{10}(\text{OCBW}) + 10 \text{ dB})$ or $(-74 \text{ dBm} + 10 \text{ dB})$ whichever is less(see note 2)	2 380 2 504 2 300 2 584	-34	CW
<p>NOTE 1: OCBW is in Hz.</p> <p>NOTE 2: In case of radiated measurements using a companion device and the level of the wanted signal from the companion device cannot be determined, a relative test may be performed using a wanted signal up to $P_{\text{min}} + 26 \text{ dB}$ where P_{min} is the minimum level of wanted signal required to meet the minimum performance criteria as defined in clause 4.3.1.12.3 in the absence of any blocking signal.</p> <p>NOTE 3: The level specified is the level at the UUT receiver input assuming a 0 dBi antenna assembly gain. In case of conducted measurements, this level has to be corrected for the (in-band) antenna assembly gain (G). In case of radiated measurements, this level is equivalent to a power flux density (PFD) in front of the UUT antenna with the UUT being configured/positioned as recorded in clause 5.4.3.2.2.</p>			

●Receiver Category 3

Receiver Blocking parameters receiver category 3 equipment

Wanted signal mean power from companion device (dBm)	Blocking signal frequency (MHz)	Blocking signal power (dBm) (see note 3)	Type of blocking signal
$(-139 \text{ dBm} + 10 \times \log_{10}(\text{OCBW}) + 20 \text{ dB})$ or $(-74 \text{ dBm} + 20 \text{ dB})$ whichever is less(see note 2)	2 380 2 504 2 300 2 584	-34	CW
<p>NOTE 1: OCBW is in Hz.</p> <p>NOTE 2: In case of radiated measurements using a companion device and the level of the wanted signal from the companion device cannot be determined, a relative test may be performed using a wanted signal up to $P_{\text{min}} + 30 \text{ dB}$ where P_{min} is the minimum level of wanted signal required to meet the minimum performance criteria as defined in clause 4.3.1.12.3 in the absence of any blocking signal.</p> <p>NOTE 3: The level specified is the level at the UUT receiver input assuming a 0 dBi antenna assembly gain. In case of conducted measurements, this level has to be corrected for the (in-band) antenna assembly gain (G). In case of radiated measurements, this level is equivalent to a power flux density (PFD) in front of the UUT antenna with the UUT being configured/positioned as recorded in clause 5.4.3.2.2.</p>			

9.8.3 Test Configuration

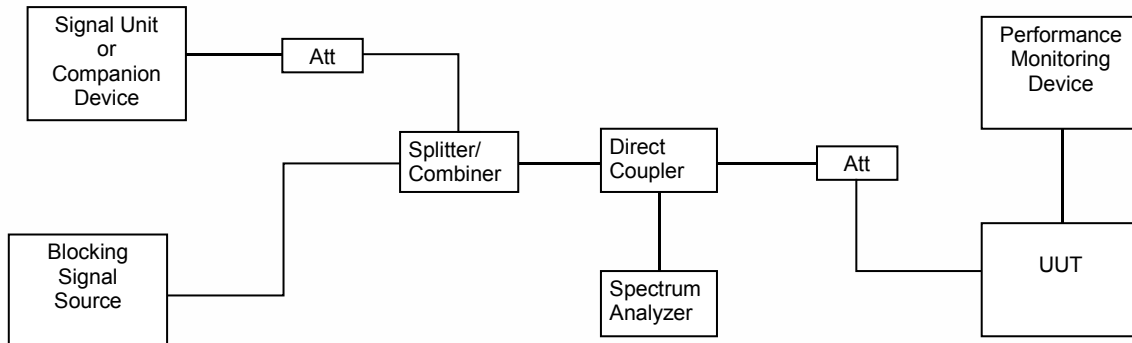

9.8.4 Test Procedure

1. Please refer to ETSI EN 300 328 (V2.2.2) clause 5.4.11.1 for the test conditions.
2. Please refer to ETSI EN 300 328 (V2.2.2) clause 5.4.11.2 for the measurement method.

■ Conducted measurement

Adaptive Frequency Hopping equipment using DAA

Step 1:

- For non-FHSS equipment, the UUT shall be set to the lowest operating channel on which the blocking test has to be performed (see clause 5.4.11.1).

Step 2:

- The blocking signal generator is set to the first frequency as defined in the appropriate table corresponding to the receiver category and type of equipment.

Step 3:

- With the blocking signal generator switched off, a communication link is established between the UUT and the associated companion device using the test setup shown in figure 6.
- Unless the option provided in note 2 of the applicable table referred to in clause 5.4.11.2.1 is used, the level of the wanted signal shall be set to the value provided in the table corresponding to the receiver category and type of equipment. The test procedure defined in clause 5.4.2, and more in particular clause 5.4.2.2.1.2, can be used to measure the (conducted) level of the wanted signal however no correction shall be made for antenna gain of the companion device (step 6 in clause 5.4.2.2.1.2 shall be ignored). This level may be measured directly at the output of the companion device and a correction is made for the coupling loss into the UUT. The actual level for the wanted signal shall be recorded in the test report.
- When the option provided in note 2 of the applicable table referred to in clause 5.4.11.2.1 is used, the attenuation of the variable attenuator shall be increased in 1 dB steps to a value at which the minimum performance criteria as specified in clause 4.3.1.12.3 or clause 4.3.2.11.3 is still met. The resulting level for the wanted signal at the input of the UUT is P_{min} . This signal level (P_{min}) is increased by the value provided in note 2 of the applicable table corresponding to the receiver category and type of equipment.

Step 4:

- The blocking signal at the UUT is set to the level provided in the table corresponding to the receiver category and type of equipment.
- If the performance criteria as specified in clause 4.3.1.12.3 or clause 4.3.2.11.3 are met then proceed to step 6.

Step 5:

- If the performance criteria as specified in clause 4.3.1.12.3 or clause 4.3.2.11.3 is not met, step 3 and step 4 shall be repeated after that the frequency of the blocking signal set in step 2 has been increased with a value equal to the Occupied Channel Bandwidth except:
 - For the blocking frequency 2 380 MHz, where this frequency offset shall be less than or equal to 10 MHz. If this frequency offset is more than 7 MHz, the level of the wanted signal shall be increased by 3 dB.
 - For the blocking frequency 2 503,5 MHz, where this frequency offset shall be less than or equal

to 10 MHz. If this frequency offset is more than 7 MHz, the level of the wanted signal shall be decreased by 3 dB.

- If the performance criteria as specified in clause 4.3.1.12.3 or clause 4.3.2.11.3 is still not met, step 3 and step 4 shall be repeated after that the frequency of the blocking signal set in step 2 has been decreased with a value equal to the Occupied Channel Bandwidth except:
 - For the blocking frequency 2 380 MHz, where this frequency offset shall be less than or equal to 10 MHz. If this frequency offset is more than 7 MHz, the level of the wanted signal shall be decreased by 3 dB.
 - For the blocking frequency 2 503,5 MHz, where this frequency offset shall be less than or equal to 10 MHz. If this frequency offset is more than 7 MHz, the level of the wanted signal shall be increased by 3 dB.
- If the performance criteria as specified in clause 4.3.1.12.3 or clause 4.3.2.11.3 is still not met, the UUT fails to comply with the Receiver Blocking requirement and step 6 and step 7 are no longer required.
- It shall be recorded in the test report whether the shift of blocking frequencies as described in the present step was used.

Step 6:

- Repeat step 4 and step 5 for each remaining combination of frequency and level for the blocking signal as provided in the table corresponding to the receiver category and type of equipment.

Step 7:

- For non-FHSS equipment, repeat step 2 to step 6 with the UUT operating at the highest operating channel on which the blocking test has to be performed (see clause 5.4.11.1).

Step 8:

- It shall be assessed and recorded in the test report whether the UUT complies with the Receiver Blocking requirement.

■ Radiated measurements

When performing radiated measurements on equipment with dedicated antennas, measurements shall be repeated for each alternative dedicated antenna.

The power levels specified in table 6, table 7, table 8, table 14, table 15 and table 16 can be converted to a corresponding power flux density (PFD) value using the formula below

$$PFD = P + 11 - 20 \times \log_{10}(300 / F)$$

'P' is the power level in dBm

'F' is the frequency in MHz

A test site as described in annex B and applicable measurement procedures as described in annex C shall be used.

The test procedure is further as described under clause 5.4.11.2.1

The level of the blocking signal at the UUT referred to in step 4 is assumed to be the level in front of the UUT antenna(s). The UUT shall be positioned with its main beam pointing towards the antenna radiating the blocking signal. The position recorded in clause 5.4.2.2.2 can be used.

9.8.5 Test Results

Receiver category

<input checked="" type="checkbox"/>	Receiver category 1	Adaptive equipment with a maximum RF output power greater than 10 dBm e.i.r.p. shall be considered as receiver category 1 equipment.
<input type="checkbox"/>	Receiver category 2	Non-adaptive equipment with a Medium Utilization (MU) factor greater than 1 % and less than or equal to 10 % or adaptive equipment with a maximum RF output power of 10 dBm e.i.r.p. shall be considered as receiver category 2 equipment.
<input type="checkbox"/>	Receiver category 3	Non-adaptive equipment with a maximum Medium Utilization (MU) factor of 1 % or adaptive equipment with a maximum RF output power of 0 dBm e.i.r.p. shall be considered as receiver category 3 equipment.

All of the modes were tested the data of the worst mode are recorded in the following pages.

Temperature:	22.6°C	Test Date:	December 01, 2022
Test Frequency:	2412MHz	OBW:	13.075 MHz
Humidity:	44%RH	Mode:	802.11b

Blocking signal frequency (MHz)	Blocking signal power (dBm)	Wanted power (dBm)	Type of blocking signal	PER(%)	Result
2380	-30.53	-68	CW	0.1	PASS
2300	-30.53	-74	CW	0.2	PASS
2330	-30.53	-74	CW	0.0	PASS
2360	-30.53	-74	CW	0.1	PASS

Temperature:	22.6°C	Test Date:	December 01, 2022
Test Frequency:	2472MHz	OBW:	13.014 MHz
Humidity:	44%RH	Mode:	802.11b

Blocking signal frequency (MHz)	Blocking signal power (dBm)	Wanted power (dBm)	Type of blocking signal	PER(%)	Result
2504	-30.53	-68	CW	0.0	PASS
2524	-30.53	-74	CW	0.1	PASS
2584	-30.53	-74	CW	0.1	PASS
2674	-30.53	-74	CW	0.1	PASS

10. APPENDIX PHOTOGRAPHS OF TEST SETUP

Spurious Emission Test Setup (Below 1GHz)

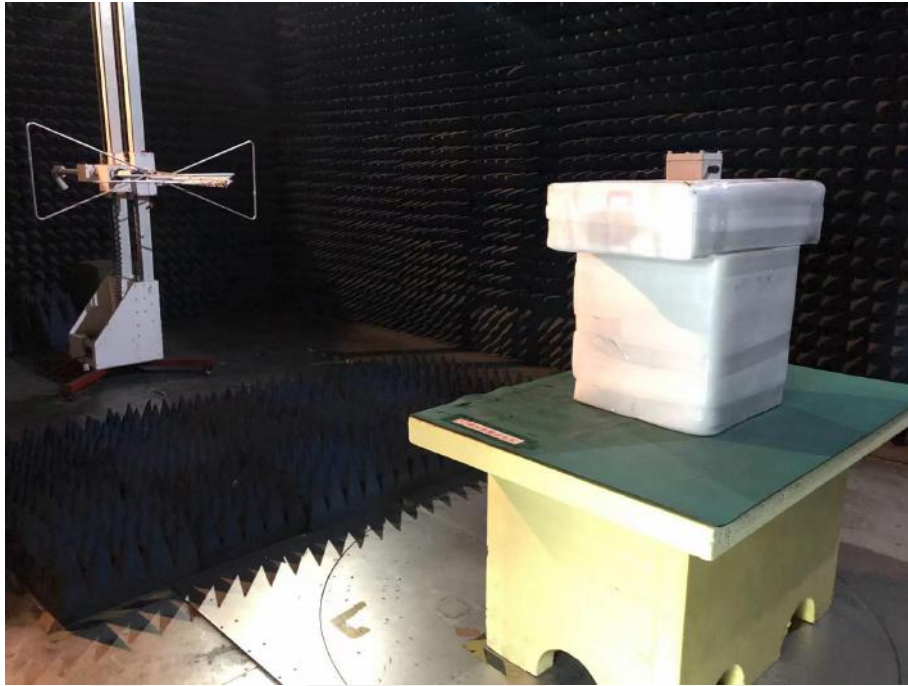

Spurious Emission Test Setup (Above 1GHz)

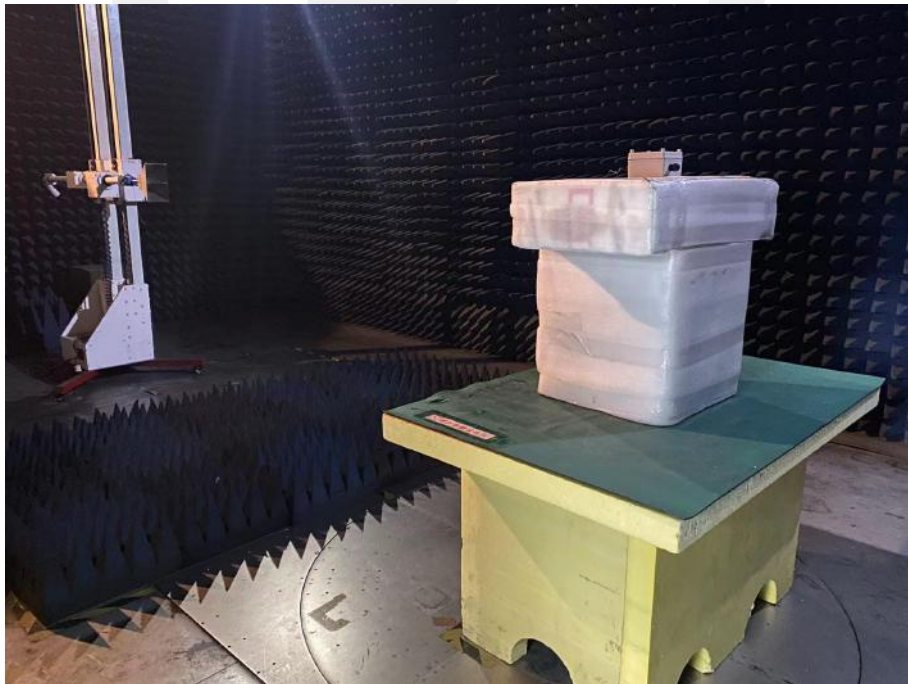

*** End of Report ***

声明

Statement

1. 本报告无授权批准人签字及“检验报告专用章”无效；

This report will be void without authorized signature or special seal for testing report.

2. 未经许可本报告不得部分复制；

This report shall not be copied partly without authorization.

3. 本报告的检测结果仅对送测样品有效，委托方对样品的代表性和资料的真实性负责；

The test results or observations are applicable only to tested sample. Client shall be responsible for representativeness of the sample and authenticity of the material.

4. 本检测报告中检测项目标注有特殊符号则该项目不在资质认定范围内，仅作为客户委托、科研、教学或内部质量控制等目的使用；

The observations or tests with special mark fall outside the scope of accreditation, and are only used for purpose of commission, research, training, internal quality control etc.

5. 本检测报告以实测值进行符合性判定，未考虑不确定度所带来的风险，本实验室不承担相关责任，特别约定、标准或规范中有明确规定的除外；

The test results or observations are provided in accordance with measured value, without taking risks caused by uncertainty into account. Without explicit stipulation in special agreements, standards or regulations, EMTEK shall not assume any responsibility.

6. 对本检测报告若有异议，请于收到报告之日起 20 日内提出；

Objections shall be raised within 20 days from the date receiving the report.