



X3-PRO G2 Series User Manual

8 kW - 30 kW



SolaX Power Network Technology (Zhejiang) Co., Ltd.

ADD.: No. 288, Shizhu Road, Tonglu Economic Development Zone,
Tonglu City, Zhejiang Province, 310000 P. R. CHINA.

TEL.: +86 (0) 571-56260011

E-mail: info@solaxpower.com

320101016908

EN

Copyright Declaration

The copyright of this manual belongs to SolaX Power Network Technology (Zhejiang) Co., Ltd. Any corporation or individual should not plagiarize, partially or fully copy (including software, etc.), and no reproduction or distribution of it in any form or by any means shall be allowed. All rights reserved. SolaX Power Network Technology (Zhejiang) Co., Ltd. reserves the right of final interpretation.

www.solaxpower.com

Change History

Changes between document versions are cumulative. The latest version contains all updates made in previous versions.

Version 08 (Oct. 26, 2023)

- Updated 2.3 Explanation of Symbols (Added the BIS Logo)
- Updated 4.4 General Data (Updated the data)
- Updated 5 Installation and 6 Electrical Connections (Updated contents related to PV terminals)

Version 07 (Jul. 05, 2023)

- Added X3-PRO-10KW-G2 model and all related contents
- Updated 4.2 AC Output (Added PEA data for 30K)
- Updated 5 Installation and 6 Electrical Connections (Updated the figures and descriptions)
- Added Appendix: Australian Version DC Switch

Version 06 (Dec. 27, 2022)

- Updated 2.3 Explanation of Symbols (Modified the explanations of the symbols)
- Updated 4 Technical Data (Modified and added new items)
- Updated 6.2 Grid Connection (Modified "Table: Cable and Micro-breaker recommended")
- Updated 7.2 LCD Function & Operation (Added a diagram to "PV Connection")

Version 05 (Sep. 9, 2022)

- Updated 2.3 Explanation of Symbols (Modified the TUV mark Logo)
- Updated 2.4 EC Directives (Updated the specific standards)

Version 04 (Jul. 20, 2022)

- Updated 6.4.3.2 Parallel Connection (Modified Wiring operation)

Version 03 (Jun. 23, 2022)

- Added the -LV models which work in low voltage and all related contents
- Modified the layout of the contents and added a new chapter as 6 Electrical Connections (Modified the contents of Communication Connection and added descriptions of parallel connection and EV-Charger function)
- Updated 4 Technical Data (Added Max. MPPT power limit per MPPT; Modified the Safety & Protection part)
- Updated 6.3 Earth Connection (Modified the descriptions of earth connection)
- Updated 7.2 LCD Function & Operation (Added setting descriptions related to parallel connection and EV-Charger function)

Version 02 (Jan. 11, 2022)

- Updated all the figures of inverter
- Updated 4 Technical Data (Modified the value for Nominal AC voltage and Nominal AC output current; Modified the Safety & Protection part)
- Updated 5.2 Packing List (Updated the pictures and descriptions)
- Updated 5.5 Connection of the Inverter (Modified connection steps of grid connection)
- Updated 6.2 LCD Function & Operation (Modified the flow diagram of Grid Protection and the description of Safety and Grid Services)
- Updated 7.1 Trouble shooting (Added PowerTypeFault)

Version 01 (Nov. 10, 2021)

- Modified the model names
- Updated 2.3 Explanation of Symbols (Deleted SAA Logo and explanation)
- Updated 5.2 Packing List (Updated the pictures and descriptions)
- Updated 5.4.2 Mounting (Modified wall mounting pictures and descriptions)
- Updated 5.5 Connection of the Inverter (Modified connection steps of grid connection and the torque)
- Added the Warranty Registration Form

Version 00 (Aug. 24, 2021)

- Initial release

Contents

1 Notes on this Manual	03
1.1 Scope of Validity.....	03
1.2 Target Group	03
1.3 Symbols Used.....	03
2 Safety	04
2.1 Appropriate Usage	04
2.2 Important Safety Instructions	06
2.3 Explanation of Symbols	08
2.4 EC Directives	10
3 Introduction.....	11
3.1 Basic Features.....	11
3.2 Terminals of the Inverter	11
3.3 Dimension	12
4 Technical Data.....	13
4.1 DC Input.....	13
4.2 AC Output	14
4.3 Efficiency, Safety and Protection	16
4.4 General Data	17
5 Installation	19
5.1 Check for Transport Damage	19
5.2 Packing List.....	19
5.3 Installation Precaution	20
5.4 Installation Steps.....	21
5.4.1 Installation Space Requirements	22
5.4.2 Mounting	23
6 Electrical Connections.....	26
6.1 PV Connection.....	26
6.2 Grid Connection	30
6.3 Earth Connection.....	35

6.4 Communication Connection.....37

 6.4.1 Monitoring Connection (Optional)37

 6.4.2 COM Connection38

 6.4.3 RS485/Meter Connection.....40

 6.4.3.1 Meter Connection (Optional).....42

 6.4.3.2 Parallel Connection43

 6.4.3.3 EV-Charger Function.....47

 6.4.3.4 Special Notice49

 6.4.4 Upgrade.....50

6.5 Run the inverter52

7 Operation Method 53

 7.1 Control Panel.....53

 7.2 LCD Function & Operation.....54

8 Troubleshooting 69

 8.1 Troubleshooting69

 8.2 Routine Maintenance.....72

9 Decommissioning 73

 9.1 Dismantling the Inverter.....73

 9.2 Packaging.....73

 9.3 Storage and Transportation.....73

 9.4 Waste Disposal.....73

10 Disclaimer..... 74

Appendix: Australian Version DC Switch..... 75

*** Warranty Registration Form**

1 Notes on this Manual

1.1 Scope of Validity

This manual is an integral part of X3-PRO G2 Series. It describes the assembly, installation, commissioning, maintenance and failure of the product. Please read it carefully before operating.

X3-PRO-8K-G2(2D)	X3-PRO-10K-G2(2D)	X3-PRO-12K-G2(2D)
X3-PRO-15K-G2(2D)	X3-PRO-17K-G2(2D)	X3-PRO-20K-G2(2D)
X3-PRO-15K-G2(3D)	X3-PRO-17K-G2(3D)	X3-PRO-20K-G2(3D)
X3-PRO-25K-G2(3D)	X3-PRO-30K-G2(3D)	X3-PRO-10KW-G2 *
X3-PRO-10K-G2-LV	X3-PRO-12K-G2-LV	X3-PRO-15K-G2-LV

Note: **"X3"** means three phases. **"PRO"** means product series name. **"8K"** means rated output power is 8 kW. **"G2"** means this product is the second generation machine of the series. **"2D"** means two inputs of MPPT and with DC switch. **"3D"** means three inputs of MPPT and with DC switch. **"LV"** means the inverter works in 127 V a.c. /220 V a.c. low voltage range.

* This model is specially for Belgium.





Keep this manual at where it is accessible all the time.

1.2 Target Group

This manual is for qualified electricians. The tasks described in this manual only can be performed by qualified electricians.

1.3 Symbols Used

The following types of safety instructions and general information appear in this document as described below:

	Danger! "Danger" indicates a hazardous situation which, if not avoided, will result in death or serious injury.
	Warning! "Warning" indicates a hazardous situation which, if not avoided, could result in death or serious injury.
	Caution! "Caution" indicates a hazardous situation which, if not avoided, could result in minor or moderate injury.
	Note! "Note" provides tips that are valuable for the optimal operation of your product.

2 Safety

2.1 Appropriate Usage

The series inverters are PV inverters which can convert DC power from PV generators to AC power and feed it into the public grid.

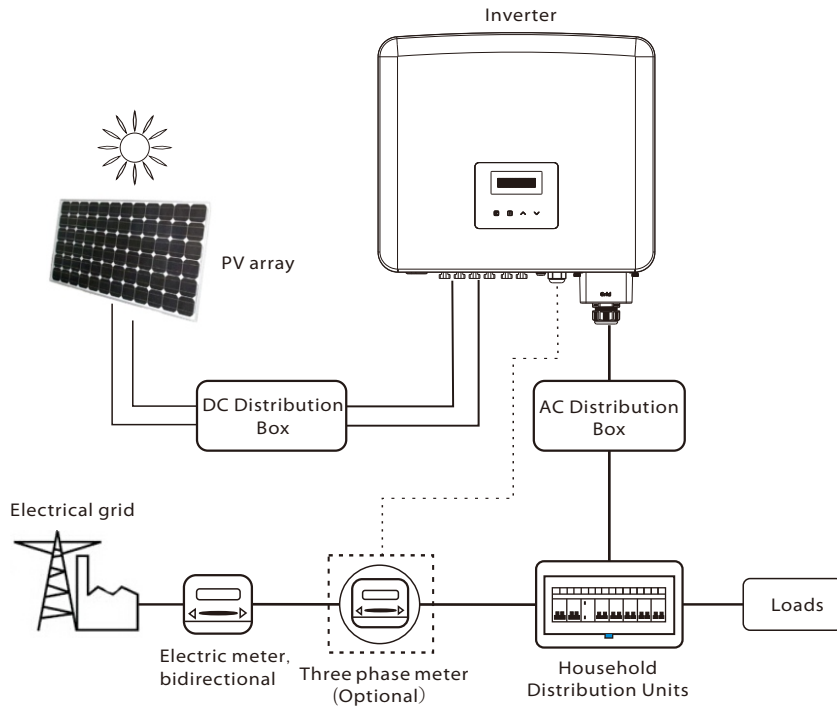

► Surge protection devices (SPDs) for PV installation



Warning!

Over-voltage protection with surge arresters should be provided when the PV power system is installed. The grid connected inverter is fitted with SPDs in both PV input side and MAINS side.

Lightning will cause a damage either from a direct strike or from surges due to a nearby strike.

Induced surges are the more likely cause of lightning damage in majority of installations, especially in rural areas where electricity is usually provided by long overhead lines. Surges may be induced on both the PV array conductors or the AC cables leading to the building.

Specialists in lightning protection should be consulted in the actual application. Using appropriate external lightning protection, the effect of a direct lightning strike into a building can be mitigated in a controlled way, and the lightning current can be discharged into the ground.

Installation of SPDs to protect the inverter against mechanical damage and excessive stress include a surge arrester in case of a building with external lightning protection system (LPS) when separation distance is kept.

To protect the DC system, Surge Protection Device (SPD type 2) should be fitted at the inverter end of the DC cabling and at the array located between the inverter and the PV generator.

To protect the AC system, surge protection devices (SPD type 2) should be fitted at the main incoming point of AC supply (at the consumer's cutout), located between the inverter and the meter/distribution system; SPD (test impulse D1) for signal line according to EN 61632-1.

All DC cables should be installed to provide as short a run as possible, positive and negative cables of the string or main DC supply should be bundled together. Avoiding the creation of loops in the system. This requirement for short runs and bundling includes any associated earth bundling conductors.

Spark gap devices are not suitable to be used in DC circuits once conducting, they won't stop conducting until the voltage across their terminals is typically more than 30 volts.

► Anti-Islanding Effect

Islanding effect is a special phenomenon that grid-connected PV system still supplies power to the nearby grid when the grid loss happened in the power system. It is dangerous for maintenance personnel and the public. The series inverters provide Active Frequency Drift (AFD) to prevent islanding effect.

2.2 Important Safety Instructions



Danger!

Danger to life due to high voltages in the inverter!

- All work must be carried out by qualified electrician.
- The appliance is not to be used by children or persons with reduced physical sensory or mental capabilities, or lack of experience and knowledge, unless they have been given supervision or instruction.
- Children should be supervised to ensure that they do not play with the appliance.



Caution!

Danger of burn injuries due to hot enclosure parts!

- During operation, the upper lid of the enclosure and the enclosure body may become hot.
- If necessary, touch the lower temperature enclosure lid during operation.



Caution!

Possible damage to health as a result of the effects of radiation!

- Do not stay closer than 20 cm to the inverter for a long time.



Note!

Grounding the PV generator.

- Comply with the local requirements for grounding the PV modules and the PV generator. It is recommended to connect the generator frame and other electrically conductive surfaces in a manner which ensures continuous conduction and ground these in order to have optimal protection of system and persons.



Warning!

- Ensure input DC voltage \leq Max. DC voltage. Over voltage may cause permanent damage to inverter or other losses, which will not be included in warranty!



Warning!

- Authorized service personnel must disconnect both AC and DC power from the inverter before attempting any maintenance or cleaning or working on any circuits connected to the inverter.



Warning!

Do not operate the inverter when the device is running.



Warning!

Risk of electric shock!

- Prior to the application, please read this section carefully to ensure correct and safe application. Please keep the user manual properly.
- Use only attachments recommended. Otherwise may result in a risk of fire, electric shock, or injury to person.
- Make sure that existing wiring is in good condition and that wire is not undersized.
- Do not disassemble any parts of inverter which are not mentioned in installation guide. It contains no user-serviceable parts. See Warranty for instructions on obtaining service. Attempting to service the inverter yourself may result in a risk of electric shock or fire and will void your warranty. Keep away from flammable, explosive materials to avoid fire disaster.
- The installation place should be away from humid or corrosive substance.
- Authorized service personnel must use insulated tools when installing or working with this equipment.
- PV modules shall have an IEC 61730 class A rating.
- Never touch either the positive or negative pole of PV connecting device. Strictly prohibit touching both of them at the same time.
- The unit contains capacitors that remain charged to a potentially lethal voltage after the MAINS and PV supply have been disconnected.
- Hazardous voltage will present for up to 5 minutes after disconnection from power supply.
- CAUTION - RISK of electric shock from energy stored in capacitor. Never operate on the solar inverter couplers, The MAINS cables, PV cables or the PV generator when power is applied. After switching off the PV and Mains, always wait for 5 minutes to let the intermediate circuit capacitors discharge before you unplug DC and MAINS couplers.
- When accessing the internal circuit of solar inverter, it is very important to wait 5 minutes before operating the power circuit or demounting the electrolyte capacitors inside the device. Do not open the device before hand since the capacitors require time to sufficiently discharge!
- Measure the voltage between terminals UDC+ and UDC- with a multi-meter (impedance at least 1 Mohm) to ensure that the device is discharged before beginning work (35 VDC) inside the device.

PE Connection and Leakage Current

- All inverters incorporate a certified internal Residual Current Device(RCD) in order to protect against possible electrocution and fire hazard in case of a malfunction in the PV array, cables or inverter. There are 2 trip thresholds for the RCD as required for certification (IEC 62109-2:2011). The default value for electrocution protection is 30 mA, and for slow rising current is 300 mA.
- If an external RCD is required by local regulations, it is recommended to choose a Type-A RCD with the rating residual current of 300 mA.

	<p>Warning! High leakage current! Earth connection essential before connecting supply.</p>
---	---

- Incorrect grounding can cause physical injury, death or equipment malfunction and increase electromagnetic.
- Make sure that grounding conductor is adequately sized as required by safety regulations.
- Do not connect the ground terminals of the unit in series in case of a multiple installation. This product can cause current with a d.c. component. Where a residual current operated protective (RCD) or monitoring (RCM) device is used for protection in case of direct or indirect contact, only an RCD or RCM is allowed on the supply side of this product.

For United Kingdom

- The installation that connects the equipment to the supply terminals shall comply with the requirements of BS 7671.
- Electrical installation of PV system shall comply with requirements of BS 7671 and IEC 60364-7-712.
- No protection settings can be altered.
- User shall ensure that equipment is so installed, designed and operated to maintain at all times compliance with the requirements of ESQCR22(1)(a).



For Australia and New Zealand

- Electrical installation and maintenance shall be conducted by licensed electrician and shall comply with Australia National Wiring Rules.













2.3 Explanation of Symbols

This section gives an explanation of all the symbols shown on the inverter and on the type label.

• Symbols on the Inverter

Symbol	Explanation
	Operating status indicator.
	Error indicator.

• Symbols on the Type Label

Symbol	Explanation
	CE mark. The inverter complies with the requirements of the applicable CE guidelines.
	Compliant with UKCA standards.
	RCM remark.
	TUV certification.
	BIS mark of conformity
	Danger. Risk of electric shock!
	Danger of high voltages. Danger to life due to high voltages in the inverter!
	Beware of hot surface. The inverter can become hot during operation. Avoid contact during operation.
	Danger to life due to high voltage. There is residual voltage in the inverter which needs 5 min to discharge. • Wait 5 min before you open the upper lid or the DC lid.
	Observe enclosed documentation.
	Do not operate this inverter until it is isolated from mains and on-site PV generation suppliers.
	The inverter can not be disposed together with the household waste. Disposal information can be found in the enclosed documentation.

Note: The table is only used for the description of symbols which may be used on the inverter. Please be subject to the actual symbols on the device.

2.4 EC Directives

This section describes the requirements of the European low voltage regulations, including safety instructions and system licensing conditions, the user must comply with these regulations when installing, operating, and maintaining the inverter, otherwise personal injury or death may occur, and the inverter will be damaged. Please read the manual carefully when operating the inverter. If you do not understand "Danger", "Warning", "Caution" and the descriptions in the manual, please contact the manufacturer or service agent before installing and operating the inverter.

Make sure that the whole system complies with the requirements of EC(2014/35/EU, 2014/30/EU, etc.) before starting the module (i.e. to start the operation).

Standard of 2014/35/EU (LVD)
EN IEC 62109-1; EN IEC 62109-2
EN 62477-1

Standard of 2014/30/EU (EMC)
EN IEC 61000-6-1; EN IEC 61000-6-2;
EN IEC 61000-6-3; EN IEC 61000-6-4;
EN IEC 61000-3-2; EN 61000-3-3;
EN IEC 61000-3-11; EN 61000-3-12
EN 55011

The assembly shall be installed in accordance with the statutory wiring rules. Install and configure the system in accordance with safety rules, including the use of specified wiring methods. The installation of the system can only be done by professional assemblers who are familiar with safety requirements and EMC. The assembler shall ensure that the system complies with the relevant national laws.

The individual subassembly of the system shall be interconnected by means of the wiring methods outlined in national/international such as the national electric code (NFPA) No. 70 or VDE regulation 4105.

3 Introduction

3.1 Basic Features

Thanks for your purchasing with the series inverter. The series inverter is one of the finest inverters on the market today, incorporating state-of-the-art technology, high reliability, and convenient control features.

- Advanced DSP control technology.
- Utilize the latest high-efficiency power component.
- Optimal MPPT technology.
 - 2/3 MPP Tracking.
 - Wide MPPT input range.
- Advanced anti-islanding solutions.
- IP66 protection level.
- Max. efficiency up to 98.5%. EU efficiency up to 98.0%.
- THD<3%.
- Safety & Reliability: transformerless design with software and hardware protection.
- Export control.
- Power factor regulation.
- Friendly HMI.
 - LED status indications.
 - LCD display technical data, human-machine interaction through press key.
 - PC remote control.
 - Upgrade through USB interface.
 - WiFi/LAN/4G dongle monitoring.

3.2 Terminals of the Inverter

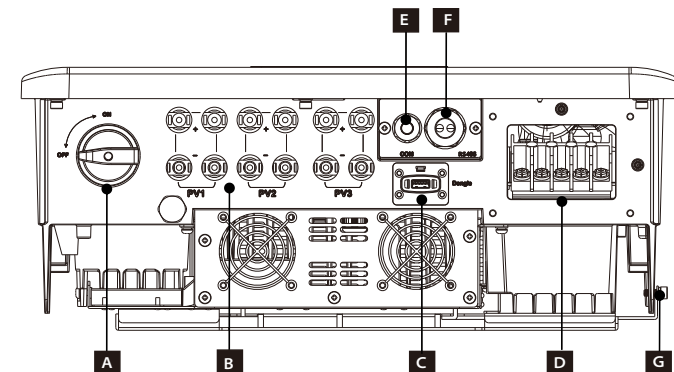

Object	Description
A	DC switch
B	PV connection port
C	Dongle port for WiFi/LAN/4G (optional)
D	AC connection port
E	COM port
F	RS485 port
G	Ground connection port

**Warning!**

Only authorized personnel is allowed to set the connection.

3.3 Dimension

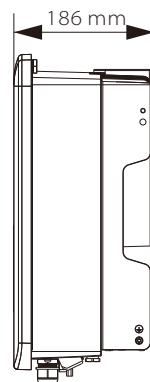
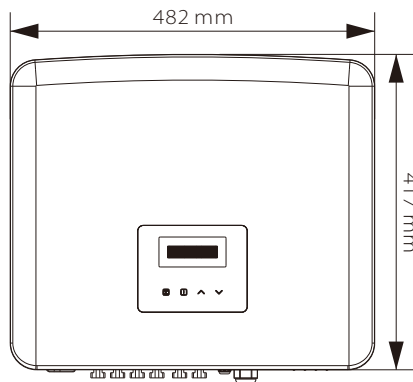

4 Technical Data

4.1 DC Input

Model	X3-PRO-8K-G2(ZD)	X3-PRO-10K-G2(ZD)	X3-PRO-12K-G2(ZD)	X3-PRO-15K-G2(ZD)	X3-PRO-17K-G2(ZD)	X3-PRO-20K-G2(ZD)
Max. PV array input power [W]	12000	15000	18000	22500	25500	30000
Max. PV voltage [d.c. V]	1100	1100	1100	1100	1100	1100
Rated input voltage [d.c. V]	650	650	650	650	650	650
MPPT voltage range [d.c. V]	160-980	160-980	160-980	160-980	160-980	160-980
MPPT voltage range @ full load [d.c. V]	350-850	350-850	350-850	400-850	400-850	400-850
Max. PV current [d.c. A]	32/32	32/32	32/32	32/32	32/32	32/32
Isc PV array short circuit current [d.c. A]	40/40	40/40	40/40	40/40	40/40	40/40
Startup voltage [d.c. V]	200	200	200	200	200	200
No. of MPPT	2	2	2	2	2	2
Strings per MPPT	A:2/B:2	A:2/B:2	A:2/B:2	A:2/B:2	A:2/B:2	A:2/B:2
Max. MPPT power limit per MPPT [W]*	8000	10000	12000	12000	12000	12000
DC disconnection switch	Yes					
Max. inverter backfeed current to the array [d.c. A]	0					

Model	X3-PRO-15K-G2(ZD)	X3-PRO-17K-G2(ZD)	X3-PRO-20K-G2(ZD)	X3-PRO-25K-G2(ZD)	X3-PRO-30K-G2(ZD)	X3-PRO-10KW-G2
Max. PV array input power [W]	22500	25500	30000	37500	45000	15000
Max. PV voltage [d.c. V]	1100	1100	1100	1100	1100	1100
Rated input voltage [d.c. V]	650	650	650	650	650	650
MPPT voltage range [d.c. V]	160-980	160-980	160-980	160-980	160-980	160-980
MPPT voltage range @ full load [d.c. V]	400-850	400-850	400-850	500-850	500-850	350-850
Max. PV current [d.c. A]	32/32/32	32/32/32	32/32/32	32/32/32	32/32/32	32/32
Isc PV array short circuit current [d.c. A]	40/40/40	40/40/40	40/40/40	40/40/40	40/40/40	40/40
Startup voltage [d.c. V]	200	200	200	200	200	200
No. of MPPT	3	3	3	3	3	2
Strings per MPPT	A:2/B:2/C:2	A:2/B:2/C:2	A:2/B:2/C:2	A:2/B:2/C:2	A:2/B:2/C:2	A:2/B:2
Max. MPPT power limit per MPPT [W]*	12000	12000	12000	15000	15000	10000
DC disconnection switch	Yes					
Max. inverter backfeed current to the array [d.c. A]	0					

Model	X3-PRO-10K-G2-LV	X3-PRO-12K-G2-LV	X3-PRO-15K-G2-LV
Max. PV array input power [W]	15000	18000	22500
Max. PV voltage [d.c. V]	800	800	800
Rated input voltage [d.c. V]	360	360	360
MPPT voltage range [d.c. V]	160-650	160-650	160-650
MPPT voltage range @ full load [d.c. V]	300-550	300-550	300-550
Max. PV current [d.c. A]	32/32	32/32	32/32
Isc PV array short circuit current [d.c. A]	40/40	40/40	40/40
Startup voltage [d.c. V]	200	200	200
No. of MPPT	2	2	2
Strings per MPPT	A:2/B:2	A:2/B:2	A:2/B:2
Max. MPPT power limit per MPPT [W]*	10000	12000	15000
DC disconnection switch	Yes		
Max. inverter backfeed current to the array [d.c. A]	0		

* "Max. MPPT power limit per MPPT" means the maximum PV production when using one of the MPPTs only.

4.2 AC Output

Model	X3-PRO-8K-G2(2D)	X3-PRO-10K-G2(2D)	X3-PRO-12K-G2(2D)	X3-PRO-15K-G2(2D)	X3-PRO-17K-G2(2D)	X3-PRO-20K-G2(2D)
Rated output apparent power [VA]	8000	10000 ¹	12000	15000 ²	17000	20000
Max. output apparent power [VA]	8800	11000 ¹	13200	16500 ²	18700	22000
Nominal AC voltage [a.c. V]	3~/N/PE, 220/380, 230/400; 3~/PE, 380, 400					
Nominal AC frequency [Hz]	50/60					
Rated output current [a.c. A]*	12.2, 11.6	15.2, 14.5	18.2, 17.4	22.8, 21.8	25.8, 24.7	30.3, 29.0
Max. output continuous current [a.c. A]	13.2	16.0	19.3	24.2	27.5	33.6
Current (inrush) [a.c. A]	60 (18 μs)					
THDi	<3%					
Power factor range	0.8 leading-0.8 lagging					
Feed-in phase	Three-phase					
Maximum output fault current [a.c. A]	100					
Maximum output overcurrent protection [a.c. A]	89					
Short circuit current [a.c. A]	300					

¹ 9999 for AS/ANS 4777.2

² 14999 for AS/ANS 4777.2

Model	X3-PRO-15K-G2(3D)	X3-PRO-17K-G2(3D)	X3-PRO-20K-G2(3D)	X3-PRO-25K-G2(3D)	X3-PRO-30K-G2(3D)	X3-PRO-10KW-G2
Rated output apparent power [VA]	15000 ³	17000	20000	25000	30000 ⁴	10000
Max. output apparent power [VA]	16500 ³	18700	22000	27500	30000 ⁵	10000
Nominal AC voltage [a.c. V]	3~/N/PE, 220/380, 230/400; 3~/PE, 380, 400					
Nominal AC frequency [Hz]	50/60					
Rated output current [a.c. A]*	22.8, 21.8	25.8, 24.7	30.3, 29.0	37.9, 36.3	45.5, 43.5	15.2, 14.5
Max. output continuous current [a.c. A]	24.2	27.5	33.6	41.8	45.5 ⁶	16.0
Current (inrush) [a.c. A]	60 (18 μs)					
THDi	<3%					
Power factor range	0.8 leading-0.8 lagging					
Feed-in phase	Three-phase					
Maximum output fault current [a.c. A]	100					
Maximum output overcurrent protection [a.c. A]	89					
Short circuit current [a.c. A]	300					

³ 14999 for AS/ANS 4777.2

⁴ 29999 for AS/ANS 4777.2

⁵ 29999 for AS/ANS 4777.2, 33000 for PEA

⁶ 47.8 for PEA

* If there are two data for this parameter, each data corresponds to the corresponding voltage.

Model	X3-PRO-10K-G2-LV	X3-PRO-12K-G2-LV	X3-PRO-15K-G2-LV
Rated output apparent power [VA]	10000	12000	15000
Max. output apparent power [VA]	11000	13200	16500
Nominal AC voltage [a.c. V]	3~/N/PE, 127/220; 3~/PE, 220		
Nominal AC frequency [Hz]	50/60		
Rated output current [a.c. A]	26.3	31.5	39.4
Max. output continuous current [a.c. A]	28.9	34.7	43.4
Current (inrush) [a.c. A]	60 (18 μs)		
THDi	<3%		
Power factor range	0.8 leading-0.8 lagging		
Feed-in phase	Three-phase		
Maximum output fault current [a.c. A]	100		
Maximum output overcurrent protection [a.c. A]	89		
Short circuit current [a.c. A]	300		

4.3 Efficiency, Safety and Protection

Model	X3-PRO-8K-G2(2D)	X3-PRO-10K-G2(2D)	X3-PRO-12K-G2(2D)	X3-PRO-15K-G2(2D)	X3-PRO-17K-G2(2D)	X3-PRO-20K-G2(2D)
MPPT efficiency	99.90%	99.90%	99.90%	99.90%	99.90%	99.90%
Euro efficiency	97.70%	97.70%	97.70%	97.80%	97.80%	97.80%
Max. efficiency	98.20%	98.20%	98.20%	98.30%	98.30%	98.30%
Safety & Protection						
Over/under voltage protection	Yes					
DC isolation protection	Yes					
DC injection monitoring	Yes					
Back feed current monitoring	Yes					
Residual current detection	Yes					
Active anti-islanding method	Frequency Shift					
Over temperature protection	Yes					
ARC detection	Optional					
SPD protection	Type II					
Arc-fault circuit interrupter(AFCI)	Optional					
AC auxiliary power supply(APS)	Optional					
Safety	IEC/EN 62109-1/-2					
Grid monitoring	EN50549, VDE-AR-N 4105, CEI 0-16, CEI 0-21, G98, G99, AS/NZS 4777.2					

Model	X3-PRO-15K-G2(3D)	X3-PRO-17K-G2(3D)	X3-PRO-20K-G2(3D)	X3-PRO-25K-G2(3D)	X3-PRO-30K-G2(3D)	X3-PRO-10KW-G2
MPPT efficiency	99.90%	99.90%	99.90%	99.90%	99.90%	99.90%
Euro efficiency	97.80%	97.80%	97.80%	98.00%	98.00%	97.70%
Max. efficiency	98.30%	98.30%	98.30%	98.50%	98.50%	98.20%
Safety & Protection						
Over/under voltage protection	Yes					
DC isolation protection	Yes					
DC injection monitoring	Yes					
Back feed current monitoring	Yes					
Residual current detection	Yes					
Active anti-islanding method	Frequency Shift					
Over temperature protection	Yes					
ARC detection	Optional					
SPD protection	Type II					
Arc-fault circuit interrupter(AFCI)	Optional					
AC auxiliary power supply(APS)	Optional					
Safety	IEC/EN 62109-1/-2					
Grid monitoring	EN50549, VDE-AR-N 4105, CEI 0-16, CEI 0-21, G98, G99, AS/NZS 4777.2					

Model	X3-PRO-10K-G2-LV	X3-PRO-12K-G2-LV	X3-PRO-15K-G2-LV
MPPT efficiency	99.90%	99.90%	99.90%
Euro efficiency	97.20%	97.20%	97.20%
Max. efficiency	97.70%	97.70%	97.70%
Safety & Protection			
Over/under voltage protection	Yes		
DC isolation protection	Yes		
DC injection monitoring	Yes		
Back feed current monitoring	Yes		
Residual current detection	Yes		
Active anti-islanding method	Frequency Shift		
Over temperature protection	Yes		
ARC detection	Optional		
SPD protection	Type II		
Arc-fault circuit interrupter(AFCI)	Optional		
AC auxiliary power supply(APS)	Optional		
Grid monitoring	Yes		

4.4 General Data

Model	X3-PRO-8K-G2(2D)	X3-PRO-10K-G2(2D)	X3-PRO-12K-G2(2D)	X3-PRO-15K-G2(2D)	X3-PRO-17K-G2(2D)	X3-PRO-20K-G2(2D)
Dimension (W/H/D)[mm]	482x417x186					
Dimension of packing (W/H/D)[mm]	590x530x315					
Net weight [kg]	24.5	24.5	24.5	26	26	26
Gross weight [kg]	28.5	28.5	28.5	30	30	30
Installation	Wall-mounted					
Operating ambient temperature range [°C]	-30 to +60					
Storage temperature [°C]	-30 to +60					
Storage/Operation relative humidity	0%~100%, condensation					
Altitude [m]	4000					
Ingress protection	IP66					
Isolation type	Transformerless					
Protective class	I					
Night-time consumption	<3 W					
Overvoltage category	III(MAINS), II(DC)					
Pollution degree	II(Inside), III(Outside)					
Cooling concept	Natural cooling			Smart fan cooling		
Noise level [dB]	<35			<55		
Inverter Topology	Non-isolated					
Communication interface	Meter, USB, Modbus RTU, WiFi/LAN/4G (Optional), DRM					

Model	X3-PRO-15K-G2(3D)	X3-PRO-17K-G2(3D)	X3-PRO-20K-G2(3D)	X3-PRO-25K-G2(3D)	X3-PRO-30K-G2(3D)	X3-PRO-10KW-G2
Dimension (W/H/D)[mm]	482x417x186					
Dimension of packing (W/H/D)[mm]	590x530x315					
Net weight [kg]	27.5	27.5	27.5	28	28	24.5
Gross weight [kg]	31.5	31.5	31.5	32	32	28.5
Installation	Wall-mounted					
Operating ambient temperature range [°C]	-30 to +60					
Storage temperature [°C]	-30 to +60					
Storage/Operation relative humidity	0%~100%, condensation					
Altitude [m]	4000					
Ingress protection	IP66					
Isolation type	Transformerless					
Protective class	I					
Night-time consumption	<3 W					
Overvoltage category	III(MAINS), II(DC)					
Pollution degree	II(Inside), III(Outside)					
Cooling concept	Smart fan cooling					
Noise level [dB]	<55			<58		<35
Inverter Topology	Non-isolated					
Communication interface	Meter, USB, Modbus RTU, WiFi/LAN/4G (Optional), DRM					

Model	X3-PRO-10K-G2-LV	X3-PRO-12K-G2-LV	X3-PRO-15K-G2-LV
Dimension (W/H/D)[mm]	482x417x186		
Dimension of packing (W/H/D)[mm]	590x530x315		
Net weight [kg]	27.5	28	28
Gross weight [kg]	31.5	32	32
Installation	Wall-mounted		
Operating ambient temperature range [°C]	-30 to +60		
Storage temperature [°C]	-30 to +60		
Storage/Operation relative humidity	0%~100%, condensation		
Altitude [m]	4000		
Ingress protection	IP66		
Isolation type	Transformerless		
Protective class	I		
Night-time consumption	<3 W		
Overvoltage category	III(MAINS), II(DC)		
Pollution degree	II(Inside), III(Outside)		
Cooling concept	Smart fan cooling		
Noise level [dB]	<45	<55	<58
Inverter Topology	Non-isolated		
Communication interface	Meter, USB, Modbus RTU, WiFi/LAN/4G (Optional), DRM		

5 Installation

5.1 Check for Transport Damage

Make sure the inverter is intact during transportation. If there are some visible damages, such as cracks, please contact your dealer immediately.

5.2 Packing List

Open the package and fetch out the product, check the accessories at first. The packing list is shown as below.

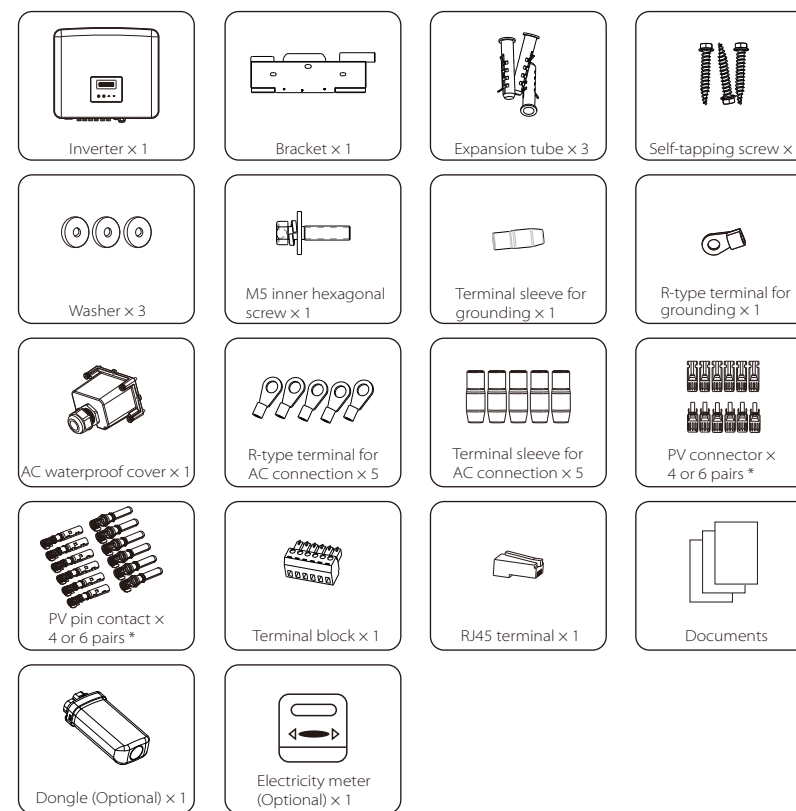

* Positive x 4 and Negative x 4 for inverters with two inputs of MPPT, Positive x 6 and Negative x 6 for inverters with three inputs of MPPT
 ** Refer to the actual delivery for the optional accessories.

5.3 Installation Precaution

The series inverter is designed for outdoor installation (IP66). Make sure the installation site meets the following conditions:

- Not in direct sunlight.
 - Not in areas where highly flammable materials are stored.
 - Not in potential explosive areas.
 - Not near the television antenna or antenna cable.
 - Not higher than altitude of about 4000 m above sea level.
 - Not in environment of precipitation or humidity.
 - Be sure the ventilation is good enough.
 - The ambient temperature in the range of -30°C to +60°C.
 - The slope of the wall should be within $\pm 5^\circ$.
- The wall hanging the inverter should meet conditions below:
1. solid brick/concrete, or strength equivalent mounting surface;
 2. Inverter must be supported or strengthened if the wall's strength isn't enough (such as wooden wall, the wall covered by thick layer of decoration)

Please avoid direct sunlight, rain exposure, snow laying up during installing and operating.

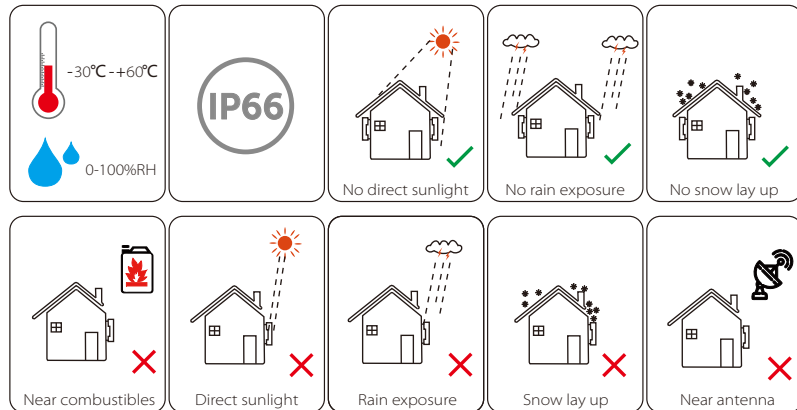

Note!
 Please do not install the inverters in parallel connection before confirming with local installer or us. For more details, please contact us.

5.4 Installation Steps

► Preparation

Below tools are needed before installation and electrical connections.

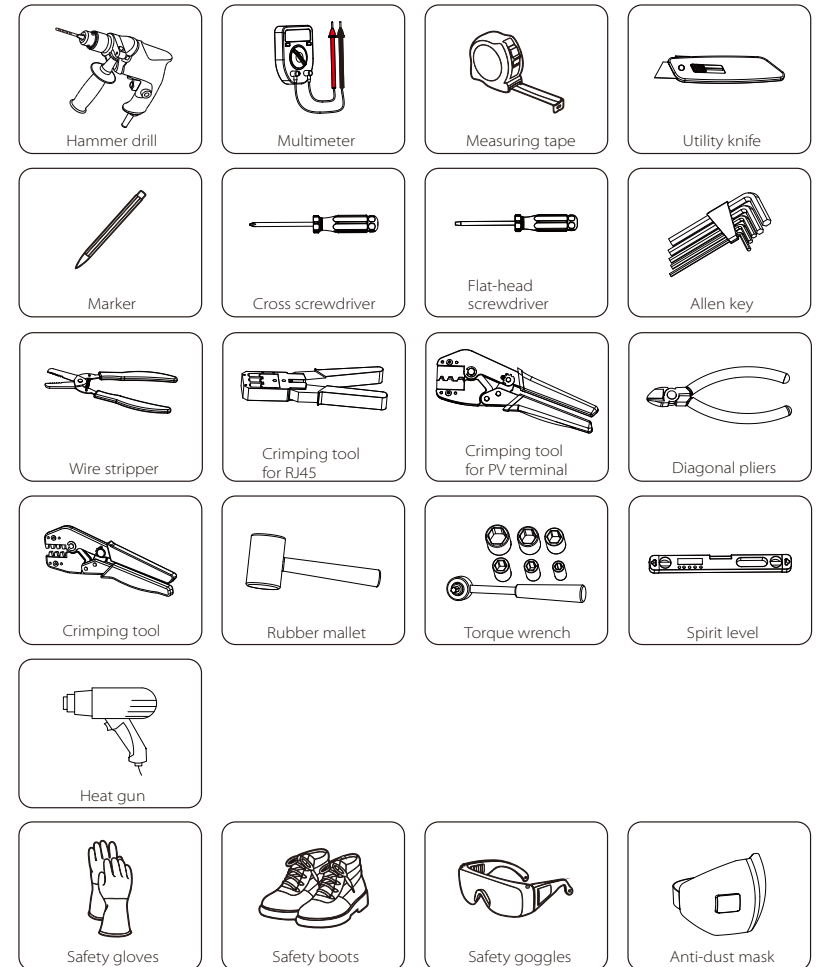

5.4.1 Installation Space Requirements

Reserve enough space when installing inverter (at least 300 mm) for heat dissipation.

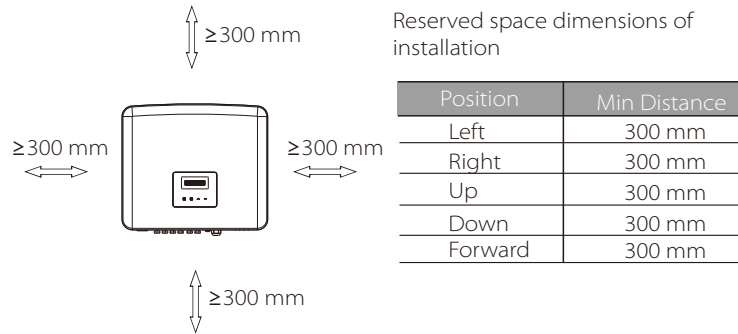

The distance of installation space for multiple inverters is as follows:

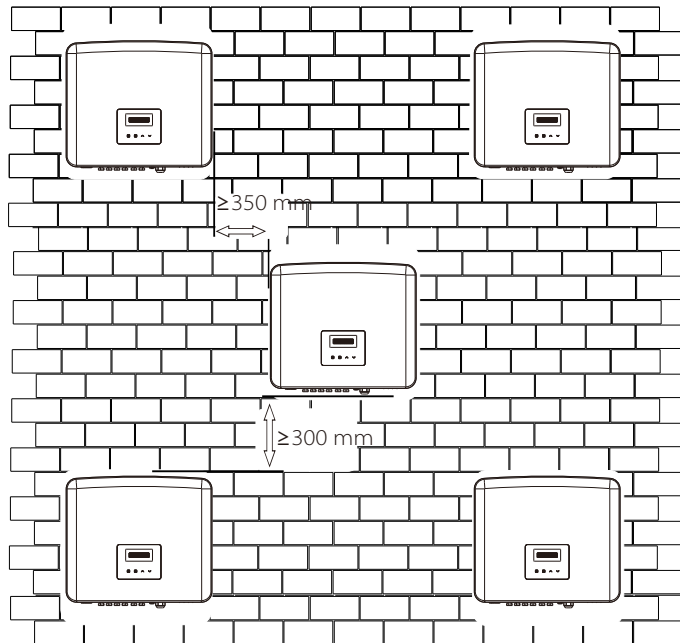

5.4.2 Mounting

➤ Step 1: Fix the bracket to the wall.

First find the expansion screw sets and the bracket in the accessory bag, as shown below:



Expansion tubes, Washers, Self-tapping screws

Bracket

a) Mark the holes on the wall with a marker.

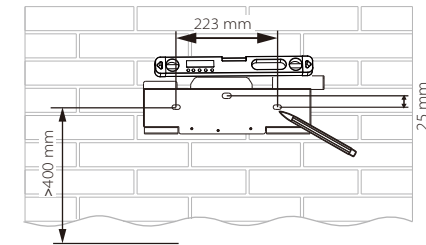

b) Drill holes at the marked points to a depth of at least 60 mm.

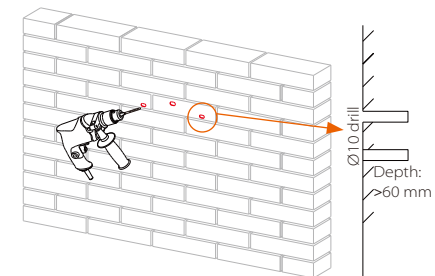

c) Insert expansion tubes into the holes, use rubber mallet to knock the expansion tubes into the wall.

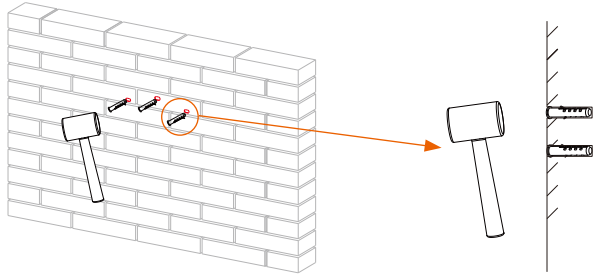

d) Insert the self-tapping screws into the washers and use the torque wrench to tighten them.

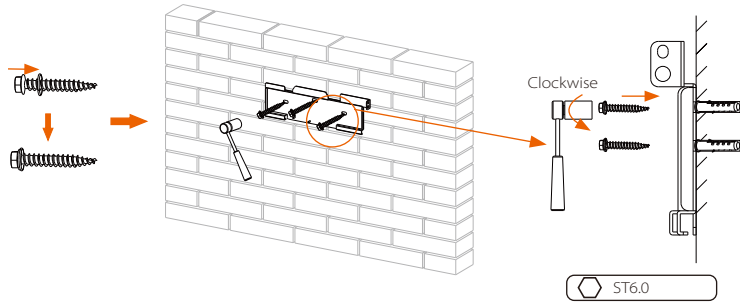

➤ Step 2: Hang the inverter on the bracket.

e) Hang the buckle of the inverter to the corresponding position of the bracket;

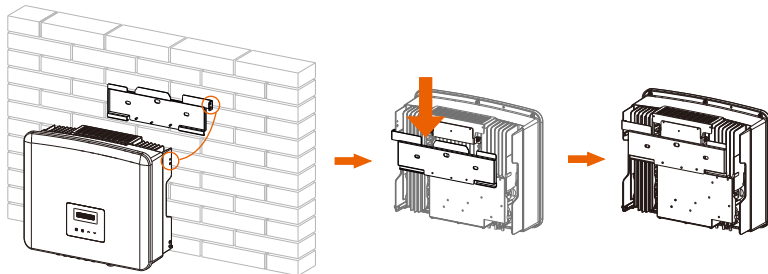

➤ Step 3: Tighten the inverter and bracket.

f) Use the Allen key to tighten the M5 inner hexagonal screw (from the accessories) on the right side of the inverter.

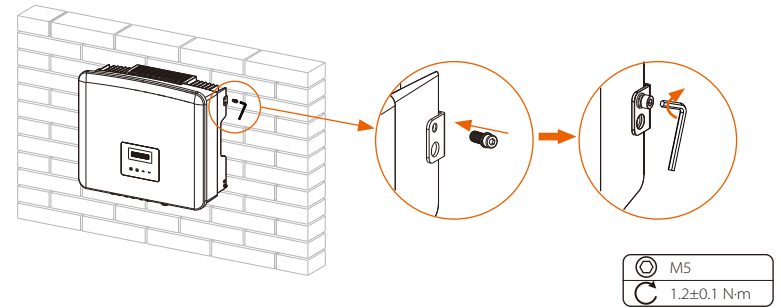

6 Electrical Connections

6.1 PV Connection

The series inverter have three couples of PV connectors which can be connected in series into at most 3-inputs of PV modules. Please select photovoltaic modules with good performance and quality assurance. The open circuit voltage of the module array should be less than the maximum PV input voltage specified by the inverter, and the operating voltage should be within the MPPT voltage range.

Table: Max. DC Voltage Limitation

Model	X3-PRO-8K-G2(2D)	X3-PRO-10K-G2(2D)	X3-PRO-12K-G2(2D)	X3-PRO-15K-G2(2D)	X3-PRO-17K-G2(2D)	X3-PRO-20K-G2(2D)
Max. DC Voltage	1100V					

Model	X3-PRO-15K-G2(3D)	X3-PRO-17K-G2(3D)	X3-PRO-20K-G2(3D)	X3-PRO-25K-G2(3D)	X3-PRO-30K-G2(3D)	X3-PRO-10KW-G2
Max. DC Voltage	1100V					

Model	X3-PRO-10K-G2-LV	X3-PRO-12K-G2-LV	X3-PRO-15K-G2-LV
Max. DC Voltage	800V		

Danger!

 Danger to life due to high voltage on DC conductors. when exposed to sunlight, the PV array generates dangerous DC voltage which is present in the DC conductors. Touching the DC conductors can lead to lethal electric shocks. Do not cover the PV modules. Do not touch the DC conductors.

Warning!

 The voltage of PV modules is very high and dangerous, please comply with the electric safety rules when connecting.

Warning!

 Do not ground the positive or negative pole of the photovoltaic module!

Note!

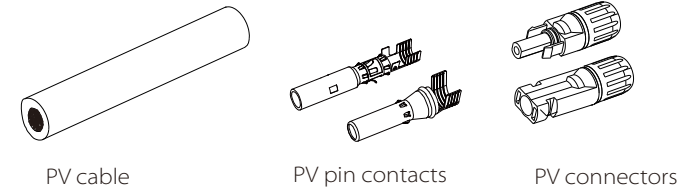
 Please follow the requirements of PV modules as below: Same type; Same quantity; Identical alignment; Identical tilt. In order to save cable and reduce the DC loss, we suggest installing the inverter near PV modules.

• Connection Steps

a) Turn off the DC switch, connect the PV module, prepare a 4 mm² PV cable, and find the PV pin contacts and PV connectors in the package.

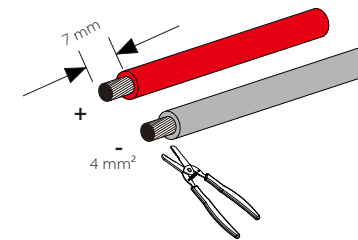

b) Use a wire stripper to strip 7 mm insulation layer from the wire end.



c) Insert the stripped section into positive pin contacts and negative pin contacts, make sure all wires are captured in the pin contacts.

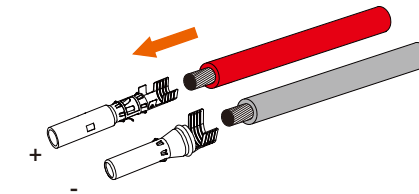

d) Use the crimping tool for PV terminals to crimp the pin contacts so that the stripped section of the PV cable is firmly contacted with the pin contacts.

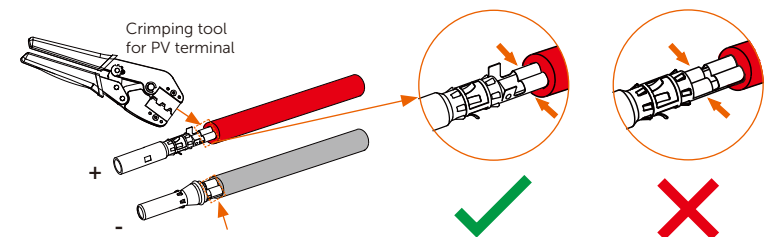

e) Loosen the cable nut from the PV connectors. Thread the cable through the cable nuts and the plugs.

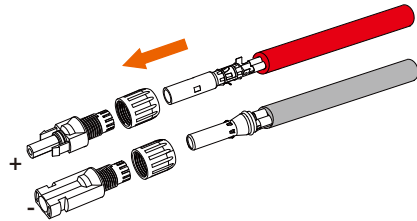

f) Force the cable pair into the plugs. There will be a sound of "Click" if the cable is correctly and completely seated.

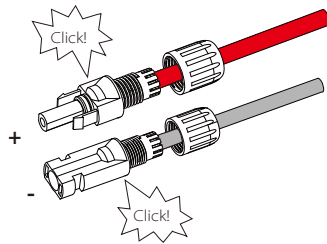

g) Tighten the cable nuts.

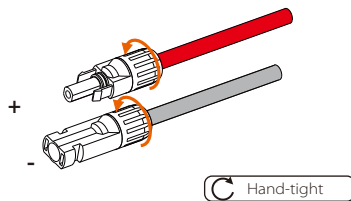

h) Before connecting to the inverter, please turn on the switch of the PV strings and use a multimeter to measure the open circuit voltage of the positive pole and negative pole of the PV cable, and make sure the open circuit voltage \leq the max. DC voltage.

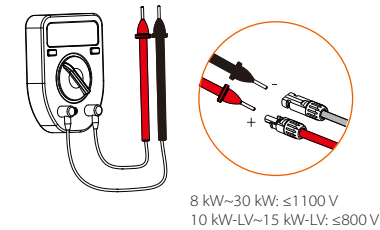

i) Remove the terminal caps from the inverter.

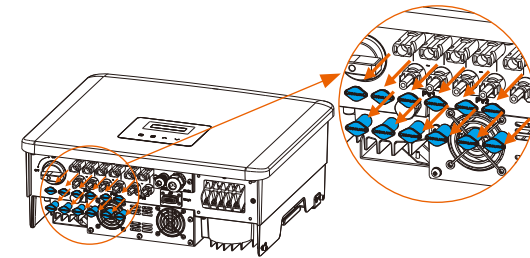

j) Connect to the corresponding port (+ and -) of the inverter and make sure to seal the unused PV terminals with the terminal caps.

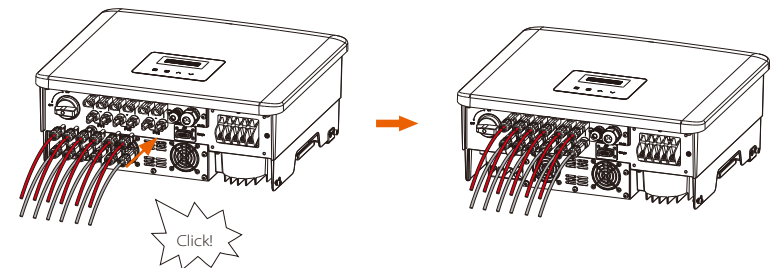

6.2 Grid Connection

The series inverter are designed for three phase grid. For the rated grid voltage and frequency, please refer to the section "Technical Data". Other technical requests should comply with the requirement of the local public grid.

Table: Cable and Micro-breaker Recommended

Model	X3-PRO-8K-G2(2D)	X3-PRO-10K-G2(2D)	X3-PRO-12K-G2(2D)	X3-PRO-15K-G2(2D)	X3-PRO-17K-G2(2D)	X3-PRO-20K-G2(2D)
L1, L2, L3 Cable	5-6 mm ²	5-6 mm ²	5-6 mm ²	5-6 mm ²	6-8 mm ²	6-8 mm ²
PE, N Cable	5-6 mm ²	5-6 mm ²	5-6 mm ²	5-6 mm ²	6-8 mm ²	6-8 mm ²
Micro-breaker	20 A	20 A	25 A	32 A	40 A	40 A

Model	X3-PRO-15K-G2(3D)	X3-PRO-17K-G2(3D)	X3-PRO-20K-G2(3D)	X3-PRO-25K-G2(3D)	X3-PRO-30K-G2(3D)	X3-PRO-10KW-G2
L1, L2, L3 Cable	5-6 mm ²	6-8 mm ²	6-8 mm ²	8-10 mm ²	10 mm ²	5-6 mm ²
PE, N Cable	5-6 mm ²	6-8 mm ²	6-8 mm ²	8-10 mm ²	10 mm ²	5-6 mm ²
Micro-breaker	32 A	40 A	40 A	50 A	63 A	20 A

Model	X3-PRO-10K-G2-1V	X3-PRO-12K-G2-1V	X3-PRO-15K-G2-1V
L1, L2, L3 Cable	6-8 mm ²	8-10 mm ²	10 mm ²
PE, N Cable	6-8 mm ²	8-10 mm ²	10 mm ²
Micro-breaker	40 A	50 A	63 A

*The cable size and conductor material of the PE/N / L1/L2/L3 should be the same. The parameters have some differences because of different environment and material. Please choose appropriate cable and micro-breaker according to the local conditions.

Micro-breaker should be installed between inverter and grid, any loads should not be connected with inverter directly.

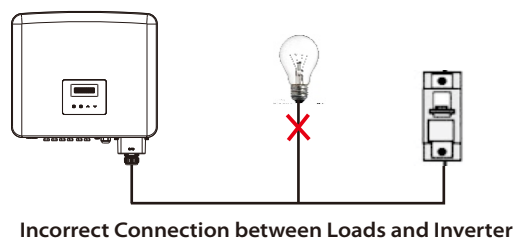

• Connection Steps

Note:
Check the grid voltage and compare with the permissive voltage range (refer to technical data).
Disconnect the circuit-breaker from all the phases and secure against re-connection.

a) Fetch the AC waterproof cover from the carton. Unscrew the fastening nut of the AC waterproof cover and remove the sealing rings.

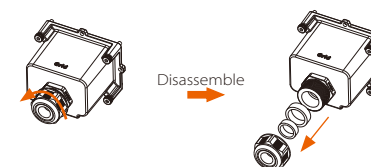

b) Select appropriate number of the sealing rings according to the outer diameter of the cable. Let the cable pass through the fastening nut, the sealing ring(s) and the waterproof cover in sequence.

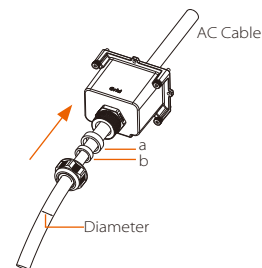

Diameter (mm)	Sealing ring(s)
12~18	a+b
18~25	a

c) Strip 82 mm of the insulation jacket from the cable ends and pull the terminal sleeves for AC connection over the wires.

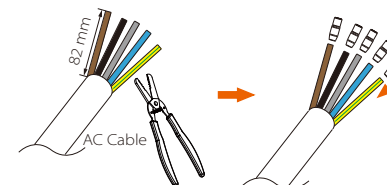

d) Strip 12 mm of insulation from the wires and put the R-Type terminals for AC connection over the stripped sections.

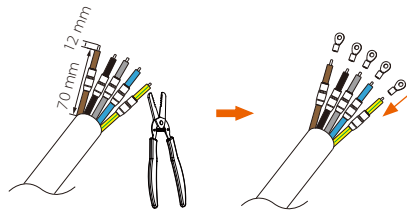

e) Crimp the R-type terminals with crimping tool, pull the terminal sleeves over the crimped sections of the R-type terminals and use a heat gun to shrink them so that they can be firmly contacted with the terminals.

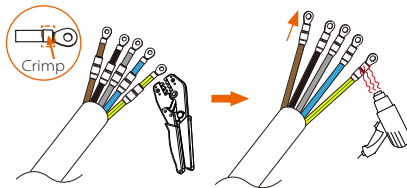

f) Take down the screws on the AC connection port of the inverter.

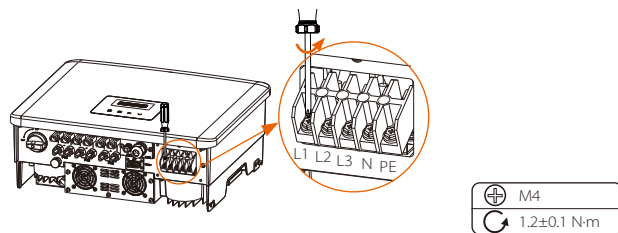

g) Connect the L1, L2, L3, N and PE wires to the inverter and tighten the screws of the wire ends with a cross screwdriver.

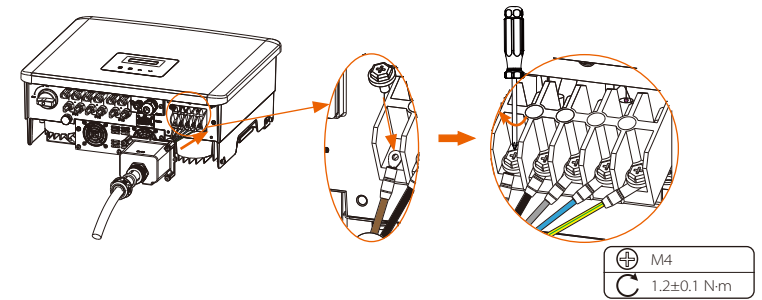

h) Align the waterproof cover and tighten the four screws with an Allen key.

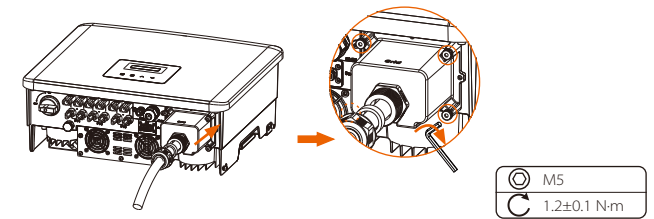

i) Tighten the waterproof fastening nut.

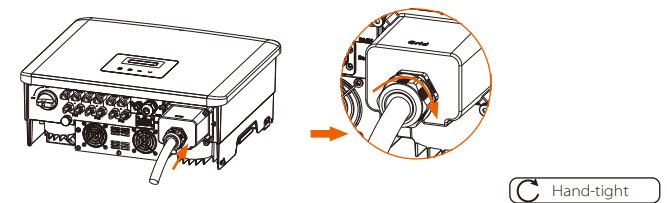

Selection of Fuses and Cables

Mains cable (AC line cable) shall be short-circuit protected and thermal overload protected.

Always fit the input cable with fuse. Normal gG (US:CC or T) fuses will protect the input cable in short circuit situation. They will also prevent damage to adjoining equipment.

Dimension the fuses according to local safety regulations, appropriate input voltage and the related current of the solar inverter.

The rated short-circuit breaking capacity of the above protective device shall be at least equal to the prospective fault current at the point of installation. See section technical data of this manual for details.

AC output cable: Cu; L1,L2,L3, N+PE: 3*5.0 mm²+2*5.0 mm² for X3-PRO-8K-G2 and 3*6.0 mm²+2*6.0 mm² for X3-PRO-10K-G2/X3-PRO-12K-G2/X3-PRO-15K-G2/X3-PRO-10KW-G2 and 3*8.0 mm²+2*8.0 mm² for X3-PRO-17K-G2/X3-PRO-20K-G2/X3-PRO-10K-G2-LV and 3*10.0 mm²+2*10.0 mm² for X3-PRO-25K-G2/X3-PRO-30K-G2/X3-PRO-12K-G2-LV/X3-PRO-15K-G2-LV @40°C ambient temperature.

Note!



1. For condition differing from those mentioned above, dimension the cables according to local safety regulations, appropriate input voltage and the load current of the unit. (You can choose a thicker cable but the fuses must be rated according to the rating of the cable.)
2. Fuses must be approved by Notified Body.

Therefore the current-carrying capacity of the components and sub-assemblies provided in the end-use system (connectors, cables, junction box, switchgear, etc.) and the reverse current PV modules shall be considered based on the feedback current and reverse current. The direct current (DC) circuit breaker or fuse between each solar generator and inverter shall be provided based on solar inverter input ratings.

Select DC cables based on the above inverter back-feed current and ISC PV rating and Vmax ratings.

6.3 Earth Connection

a) Find the terminal sleeve for grounding and the R-type terminal for grounding from the accessories. Prepare a grounding cable (6 mm²).



b) Strip 7 mm insulation layer from the end.

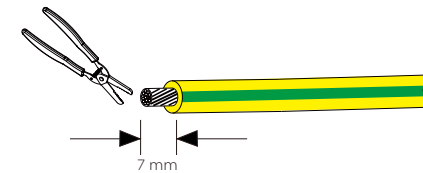

c) Pull the terminal sleeve over the cable and insert the stripped section into the R-type terminal for grounding.

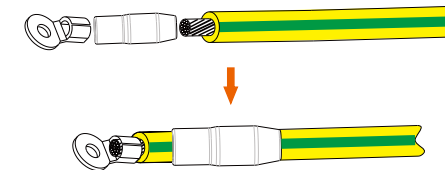

d) Crimp it with crimping tool, pull the terminal sleeve over the crimped section of the R-type terminal and use a heat gun to shrink it so that it can be firmly contacted with the terminal.

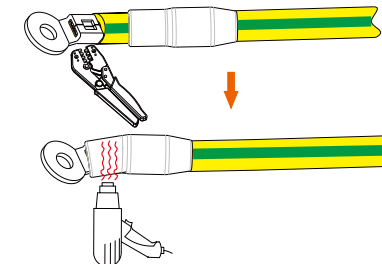

e) Remove the grounding screw from the right side of the inverter.

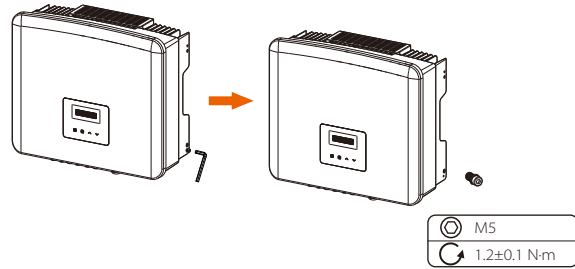

f) Tighten the ground screw with an Allen key as shown in the figure below.

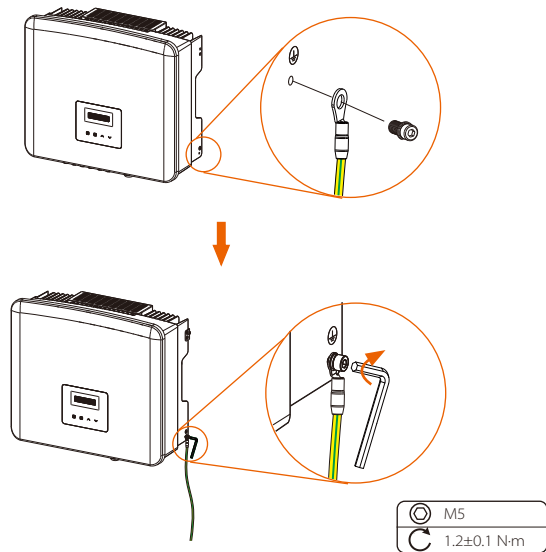

6.4 Communication Connection

This product has a series of communication interfaces: such as WiFi/LAN/GPRS, RS485/Meter, DRM and USB for upgrading for human and machine communication. Operating information like output voltage, current, frequency, faulty information, etc., can be delivered to PC or other monitoring equipment via these interfaces.

6.4.1 Monitoring Connection (Optional)

This inverter provides a monitoring dongle connecting port (the Dongle port) which can collect information from inverter including status, performance and updating information to the monitoring website via connecting WiFi/LAN/4G dongle (The monitoring dongle is optional, which can be purchased from the supplier if needed).

For example, insert the WiFi dongle into the port named "Dongle" on the bottom of the inverter.

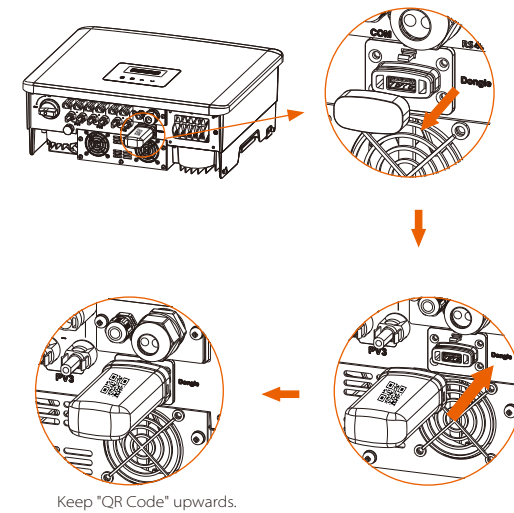

Connection steps:

Please check the user manual of the WiFi dongle for more details.

6.4.2 COM Connection

This inverter provides a COM port, through this port the inverter can achieve multiple functions like DRM (Demand Response Management), dry contact function and heat pump control via Adapter Box.

• **COM Connection Steps:**

a) Unscrew the cover on the COM port and locate the port.

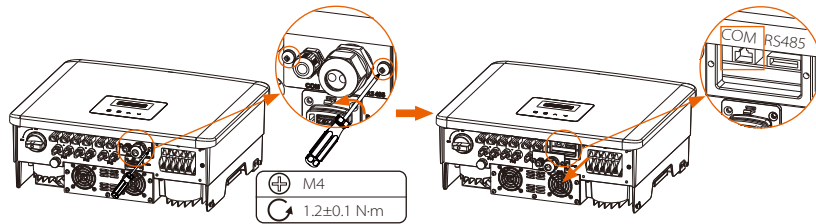

b) Loosen the nut and remove the stopper of the COM port.



c) Thread the prepared communication cable and strip the insulation from it.

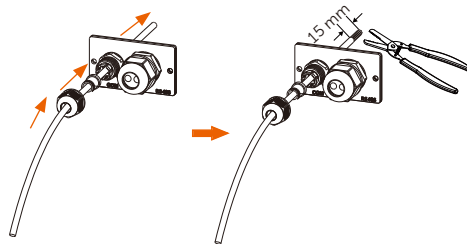

d) Insert the stripped sections into the RJ45 terminal following the PIN definition rules and crimp with the crimping tool for RJ45.

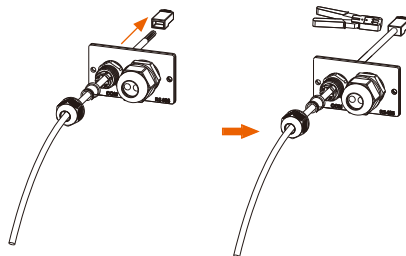

e) Connect the cable into the COM port of the inverter. Then push the cover to appropriate position and tighten the screws.

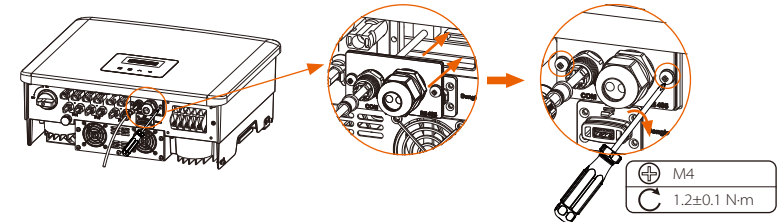

f) Tighten the nut of the COM port.

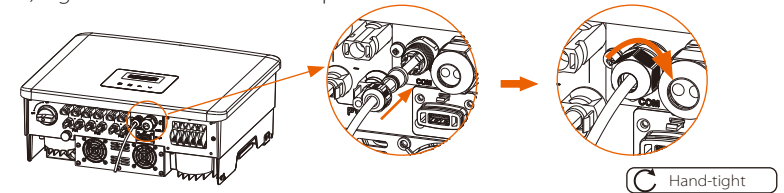

• **PIN Definitions for DRM, Dry Contact, Heat Pump Controller**

a. DRM is provided to support several demand response modes by giving control signals as below.

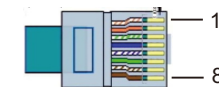

Pin	1	2	3	4	5	6	7	8
Definition	X	X	X	X	REF GEN	DRM0	X	X

Note: DRM0 (Demand Response Mode) here is specifically for AS/NZS 4777.2:2020; Short connect PIN5 (REF GEN) and PIN6 (DRM0) via external switch or relay, the inverter will reduce its output power to zero. This remote shutdown function also applies to other safety codes.

b. Dry Contact is provided to control the closing and breaking of switches by giving control signals as below.

Pin	1	2	3	4	5	6	7	8
Definition	Dry Contact+	Dry Contact-	X	X	X	X	X	X

c. Heat Pump Controller is the controlling signal provide by the inverter to switch on or off the SG ready heat pump via Adapter Box. The PIN definition is as below:

Pin	1	2	3	4	5	6	7	8
Definition	X	X	Heat Pump Controller+	Heat Pump Controller-	X	X	X	X

6.4.3 RS485/Meter Connection

There is an RS485 port on the bottom of the inverter. Through this port, the inverter can communicate with the computer, Datahub or other devices and the meter and achieve the parallel function or EV-Charger function.

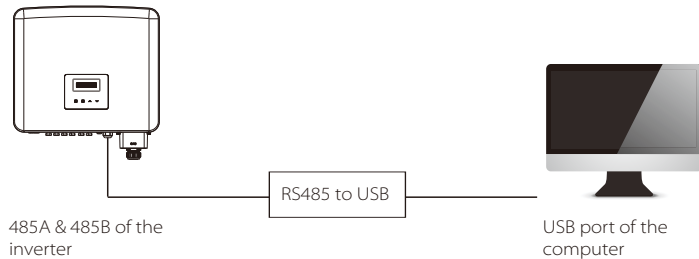

The product is equipped with a Modbus interface via RS485 port. The Modbus interface can be connected via RS485 to USB cable or external Modbus control device to SCADA systems for industrial use and has the following tasks:

- Remote query of measured values,
- Remote setting of operating parameters,
- Setpoint specifications for system control.

• **RS485 Connection Steps:**

a) Unscrew the cover on the RS485 port and locate the port.

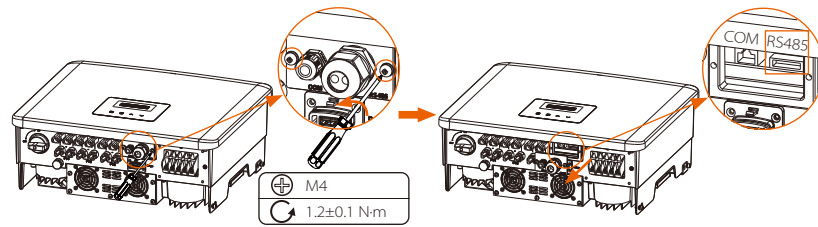

The PIN definitions of RS485 port are as below.

Pin	1	2	3	4	5	6
Definition	485A	485B	485A	485B	meter A	meter B

b) Loosen the nut and remove the stopper of the RS485 port.



c) Thread the prepared communication cable(s) as the actual application scene needed and strip the insulation from the cable(s).

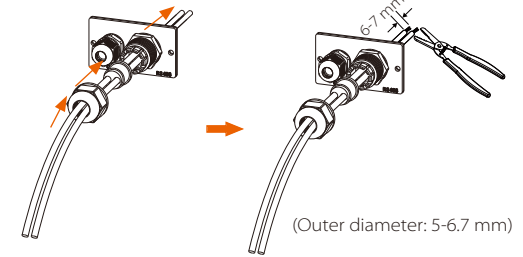

d) Insert the stripped sections into the corresponding pins of the terminal block following the PIN definition rules and tighten the screws.

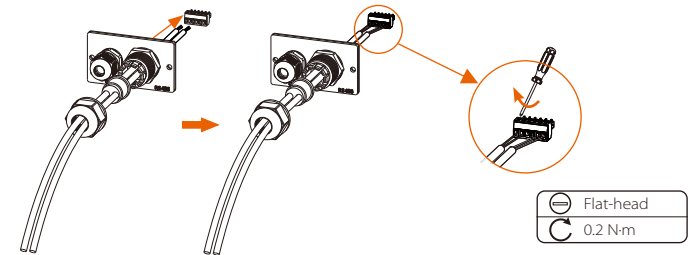

e) Insert the terminal block into the RS485 port of the inverter. Then push the cover to appropriate position and tighten the screws.

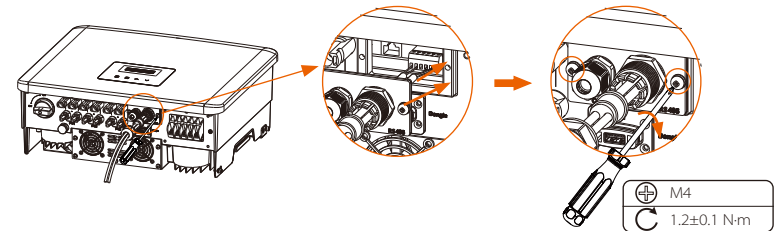

f) Tighten the nut of the RS485 port.

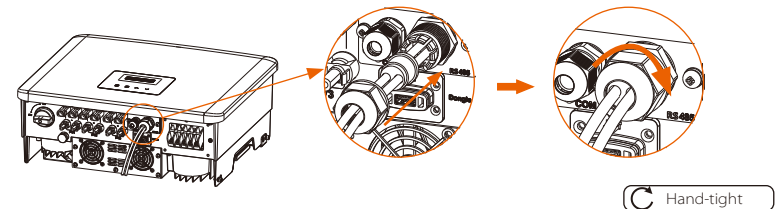



Note!

When making RS485 wiring, the wiring should be connected according to correct sequence:
 For communication with computers: 485A-485B & 485B-485A;
 For other devices (including inverters, Datahub, etc.): 485A-485A & 485B-485B.

6.4.3.1 Meter Connection (Optional)

The inverter can communicate with a meter through this interface, with the meter you can:

1. Monitor the energy to grid and from grid throughout the whole day.
2. Achieve the export control function with a higher accuracy.

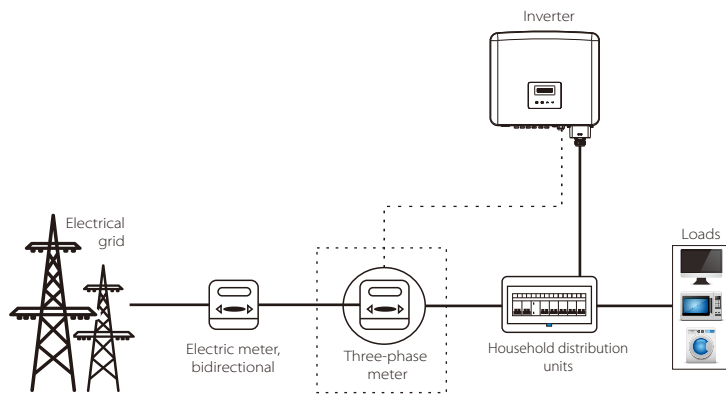

Note!

The smart meter must be authorized by us, any third party or non-authorized meter may not match with the inverter. We will not take the responsibility if the unauthorized meter is unavailable.

Meter Connection Steps:

Please see the Quick Installation Guide for three-phase meter for details.

6.4.3.2 Parallel Connection

The series inverter provides the parallel connection function, which could support several inverters to parallel in one system and can control zero injection to the grid with a meter installed in the main circuit.

The parallel system can be achieved with Modbus Function or with Datahub. Please refer to the following diagrams.

Diagram A: Parallel system with Modbus Function

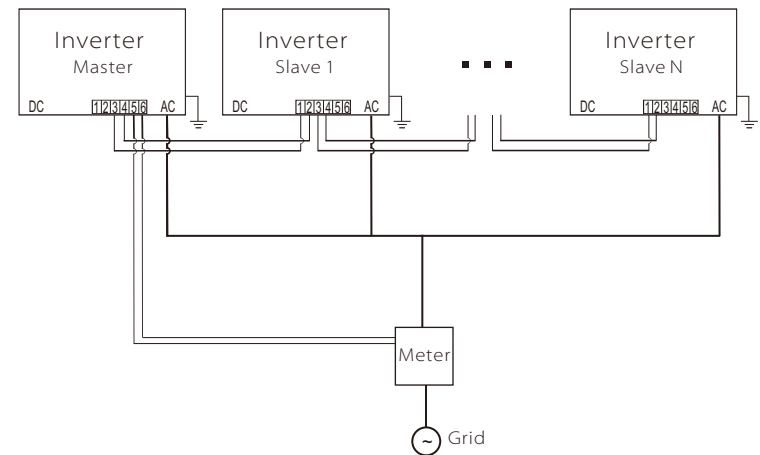
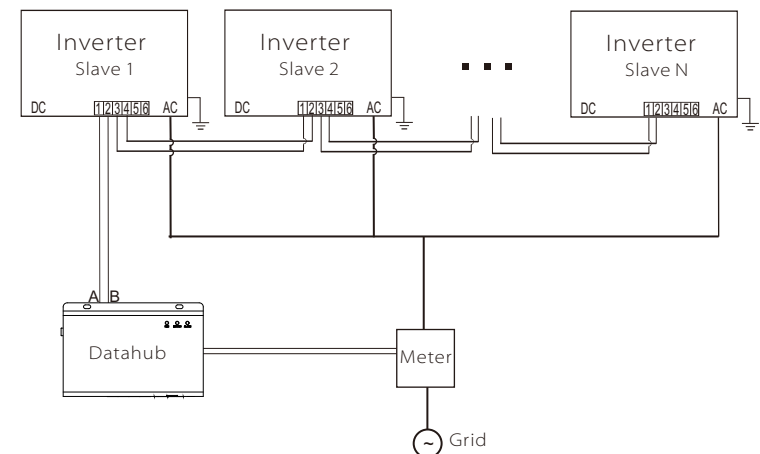

Diagram B: Parallel system with Datahub



Note!

Before operation, please make sure that the inverters meet the following conditions:

1. All the inverters are recommended to be the same series;
2. The firmware version of all inverters shall be the same. Otherwise, the parallel function cannot be used.

➤ **Parallel system with Modbus Function**

In this parallel system, at most 5 inverters can be connected. One inverter will be set as a master, and the rest are the slaves. The master inverter can communicate with all the slave inverters.

• **Wiring operation**

- a) Connect all the inverters in the parallel system with each other via RS485 cables.
- b) Connect the communication cable of the meter with the master inverter.

• **LCD setting**

Turn on the power of the entire system, enter the "Settings" page of the inverters on the LCD screen. Follow the instructions below to complete the settings.

- a) Make sure the meter is connected to the master inverter. Enter the "Export Control" page and choose "Meter" on the master inverter.

> Export Control
DRM Function

> Mode Select
Meter

- b) Enter "ParallelSetting" page, choose "Enable" to activate the function for all the inverters. Please disable this function if not needed.

> ParallelSetting
MpptScanMode

> Mode Select
Enable

- c) Select "Master" for the master inverter and "Slave" for the slave inverters. Only one inverter can be set as "Master".

> M/S Select
Master/Slave

- d) Set the value for "System Limit" on the master inverter. This will be the overall power limit for the parallel system. The output power of slaves will then be distributed respectively according to their nominal output power. The value can be set within the range of 0 kW to 180 kW and the default value is 180000 W.

> System Limit
180000W

Note!

The power limit value set in "System Limit" is the limit for the multiple inverters in the parallel system, while the "UserValue" set in "Export Control" is the power limit for a single inverter which will be nullified when the parallel function is enabled.

Note!

The parallel system with Modbus Function and the EV-Charger function cannot be used at the same time currently. If the EV-Charger is connected when multiple inverters are working in the parallel system:

When the "ParallelSetting" is enabled, the EV-Charger will become a common load and can only charge in Fast mode, other smart charging modes will not be available.

When the "ParallelSetting" is disabled, the EV-Charger function is enabled, then the EV-Charger can work normally with the inverter it is connected to, while other inverters cannot realize the export control function.

➤ **Parallel system with Datahub**

In this parallel system, at most 60 inverters can be connected. The Datahub will be the master of the system, and all the inverters are the slaves. The Datahub can communicate with all the slave inverters.

Note!

Before connecting the Datahub to the parallel system, please check that the inverters' settings meet the following conditions:



1. The "Modbus Function" should be **"COM485"**.
2. The "ParallelSetting" should be **"Disable"**.
3. The addresses of all the inverters in the "RS485 CommAddr" should be **different**. Otherwise, please reset the RS485 communication addresses.

• **Wiring operation**

- a) Connect one end of an RS485 communication cable with Datahub, and the other end with one of the slave inverters.
- b) Connect all the slave inverters with each other via RS485 cables.
- c) Connect the meter with the Datahub and the mains.

Note!



The inverter connected with the Datahub should not enable the "ParallelSetting". There is no need to set the "ParallelSetting" on the inverters, the parallel system with Datahub will start automatically.

For the details, please refer to the user manual of Datahub.

6.4.3.3 EV-Charger Function

The inverter can communicate with the smart EV-Charger to form an intelligent photovoltaic, storage and EV charging energy system, thus maximizing the utilization of photovoltaic energy.

Diagram: Intelligent Photovoltaic, Storage and EV Charging Energy System

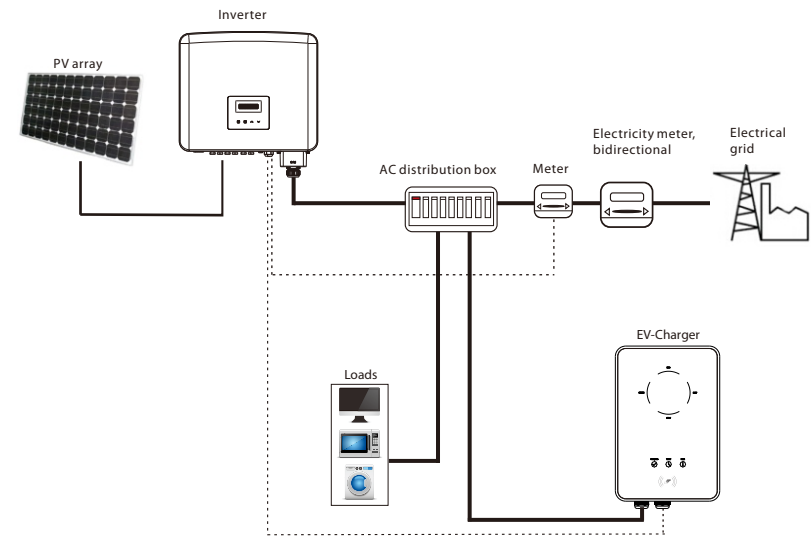

• **Wiring operation**

- a) Plug one end of the communication cable to the right pin of the EV-Charger and the other end to PIN 1 & 2 or 3 & 4 of the "RS485" port of the series inverter.
- b) Connect the meter to PIN 5 & 6 of the "RS485" port of the inverter.

• **LCD setting**

Turn on the power of the entire system, enter the "Settings" page of the inverter on the LCD screen.

- a) Enter the "Export Control" page and choose "Meter".

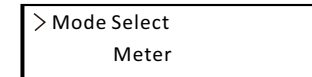
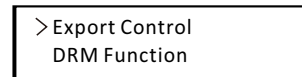

b) Enter “Modbus Fuction” and select “EV Charger”.

> Modbus Function

> Function Select
EV Charger

c) Set the “Grid Data Source” as “Inverter” in the APP of the EV-Charger.

For the installation and settings of the EV-Charger, please refer to the user manual of the EV-Charger for details.

Note!



The EV-Charger function and the parallel system with Datahub or the parallel system with Modbus Function cannot be used at the same time currently.

6.4.3.4 Special Notice

The three functions (i.e. Parallel system with Modbus Function, Parallel system with Datahub and EV-Charger function) conflict with each other due to sharing the same RS485 port and only one of the three functions can be used at a time.

If the three functions are enabled at the same time accidentally, please follow the instructions below:

1. If the “ParallelSetting” is enabled and the inverter is the master one while the system is connected with Datahub, please remove the Datahub then the parallel system will work normally. If the Datahub is to be remained in the parallel system, remove the Datahub first and disable the “ParallelSetting”, then reconnect the Datahub.
2. The parallel system and the EV-Charger function cannot be enabled at the same time. Once the EV-Charger function is enabled, remove the external RS485 wiring or connect it to the EV-Charger if the external RS485 is connected with another inverter.
3. If the EV-Charger function is enabled and Datahub is connected in the system, please remove the Datahub, then the EV-Charger will work normally. If the Datahub is to be remained in the parallel system, remove the Datahub first and change “EV Charger” to “COM485” under the “Modbus Fuction”, then reconnect the Datahub.

6.4.4 Upgrade

The inverter system can be updated through an U-disk.



Warning!

Make sure the input voltage is more than **200 V** (in good illumination condition), or it may result in failing during updating.

Upgrade Steps:

1) Please contact our service support to get the update file, and extract it into your U-disk as the following file path:

```
"update\ARM\618.xxxxx.00_XXXXXXXX_ARM_Vx.xx_xxxxxxx.usb";
"update\DSP\618.xxxxx.00_XXXXXXXX_DSP_Vx.xx_xxxxxxx.usb".
```

Note: Vx.xx is version number, xxxxxxxx is file completion dates.



Warning!

Make sure the directory is in accordance with above form strictly! Do not modify the program file name! Or it may cause the inverter to stop working!

2) Make sure the DC switch is off and the AC is disconnected with grid. If the WiFi dongle is connected to the port, please remove the WiFi dongle at first.

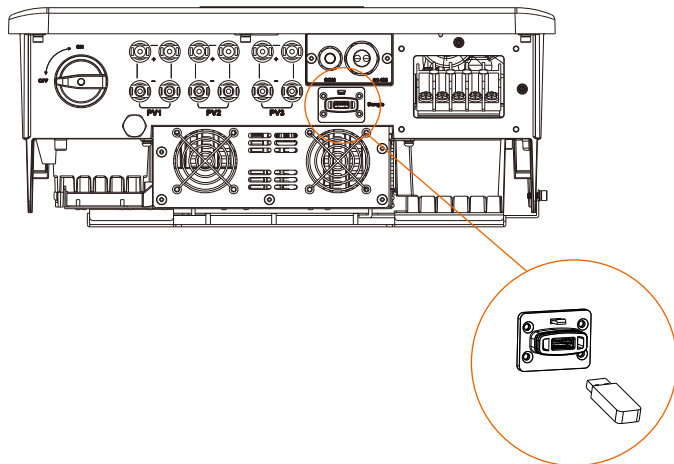

3) Then insert the U-disk into the Dongle port on the bottom of the inverter. Then turn on DC switch and connect the PV connector, the LCD will show a picture as below.

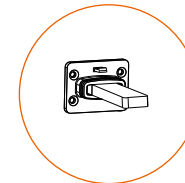
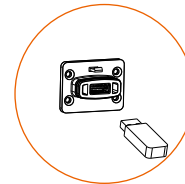

===== Update =====

> ARM
DSP

4) Press the "Up" and "Down" button to select ARM or DSP. Then long press "Down" and select the correct update file to confirm the update. ARM and DSP shall be updated one by one.

5) After the upgrade is completed, please remember to turn off the DC switch or disconnect the PV connector, then pull off the U-disk, and connect the WiFi dongle back.



Warning!

During updating, don't turn off the DC switch or disconnect the PV connector. If the updating stopped due to PV power failure, do not unplug the U-disk. When the PV power recovers, the update will continue. If the updating stopped due to other reasons, reinsert the U-disk to continue the update.

6.5 Run the inverter

Start inverter after checking all below steps:

- a) Check that device is fixed well on the wall.
- b) Make sure all the DC breakers and AC breakers are OFF.
- c) AC cable is connected to grid correctly.
- d) All PV panels are connected to inverter correctly, PV connectors which are not used should be sealed with a lid.

Start inverter

- Turn on the DC switch to the “ON” position. (For Australian version DC switch, please refer to the appendix.)
- Turn on the external AC breaker.
- Inverter will start automatically when PV panels generate enough energy.
- Check the status of LED indicators and LCD screen, the LED indicators should be blue and the LCD screen should display the main interface.
- If the LED indicator is not blue, please check the below:
 - All the connections are correct.
 - All the external disconnect switches are closed.
 - The DC switch of the inverter is in the “ON” position.

Below is the three different states when operating, which means inverter starting up successfully.

Waiting: Inverter is waiting to check when DC input voltage from panels is greater than 160 V (lowest operating voltage) but less than 200 V (lowest start-up voltage).

Checking: Inverter will check DC input environment automatically when DC input voltage from the PV panels exceeds 200 V and PV panels have enough energy to start inverter.

Normal: Inverter begins to operate normally with blue light on, meanwhile the inverter feeds back energy to the grid and the LCD displays current output power. Enter the setting interface to follow the instructions when it is first time to start up.



Warning!

Power to the unit must be turned on only after installation work has been completed. All electrical connections must be carried out by qualified personnel in accordance with legislation in force in the country concerned.



Note!

Please set the inverter if it is the first time to start up. Above steps are for the regular start of the inverter. If it is the first time to start up the inverter, you need to configure the settings for the inverter after start up.

7 Operation Method

7.1 Control Panel

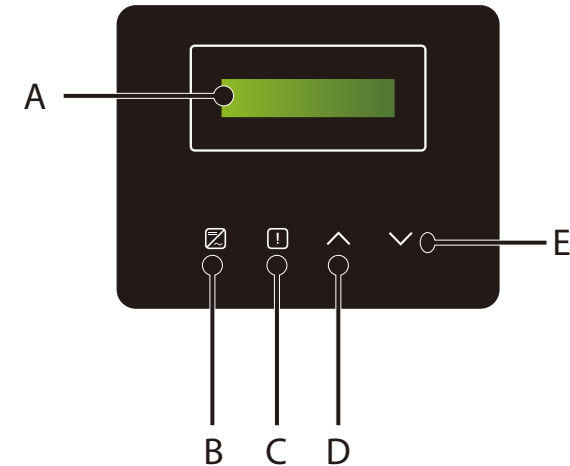

Object	Name	Description
A	LCD Screen	Display the information of the inverter.
B	LED Indicator	Light in blue: The inverter is in normal status.
C		Flash in blue: The inverter is in waiting status.
D	Function Button	Up/Back button: Move cursor to upside or increase value. Return from current interface or function.
E		Down/Enter button: Move cursor to downside or decrease value. Confirm the selection.

Note:

Key	Operation	Description
^ Up/Back	Long Press	Return to the previous menu or confirm function setting
	Short Press	Look at the previous parameter or increase the value
v Down/Enter	Long Press	Go to the next menu or confirm value change
	Short Press	Look at the next parameter or decrease the value

7.2 LCD Function & Operation

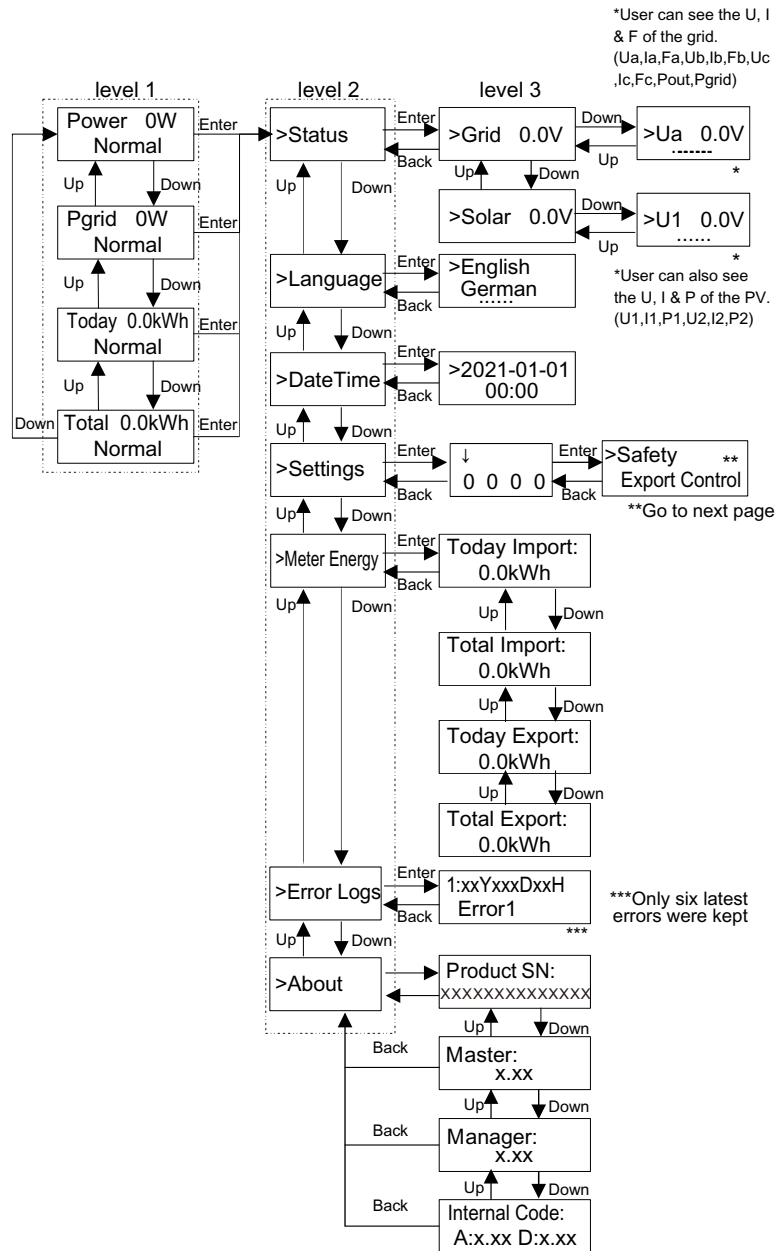

Settings page

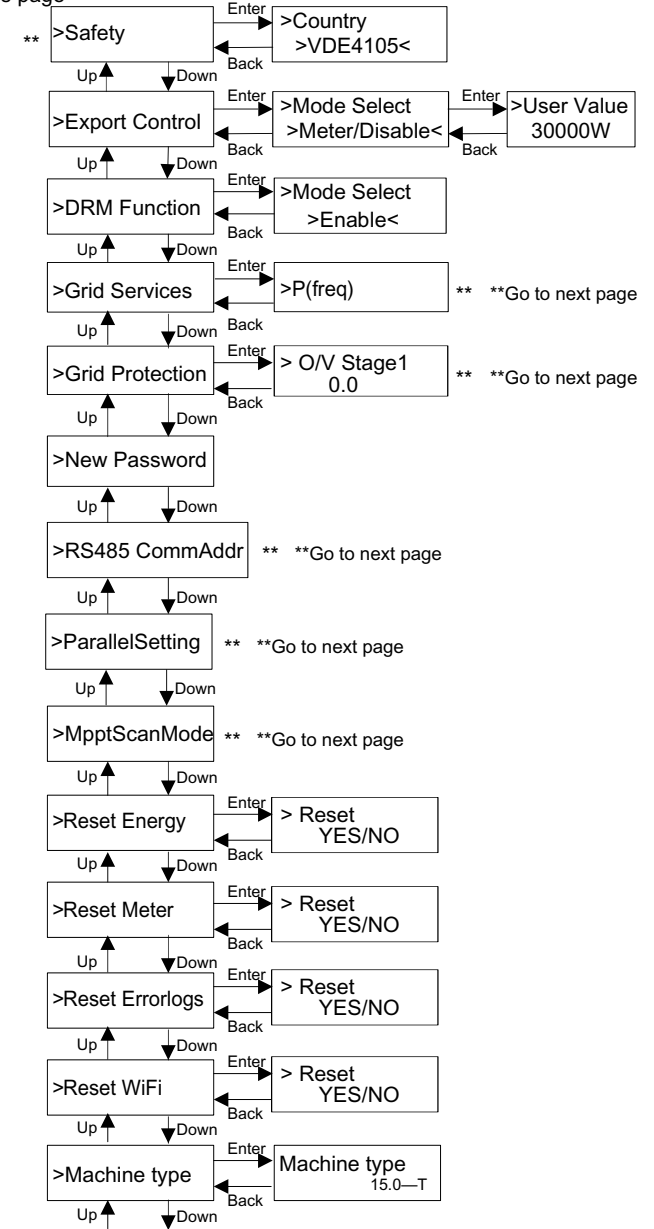

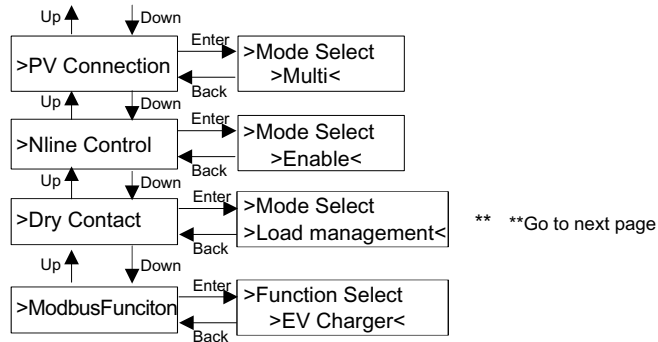

Grid Services and Grid Protection page

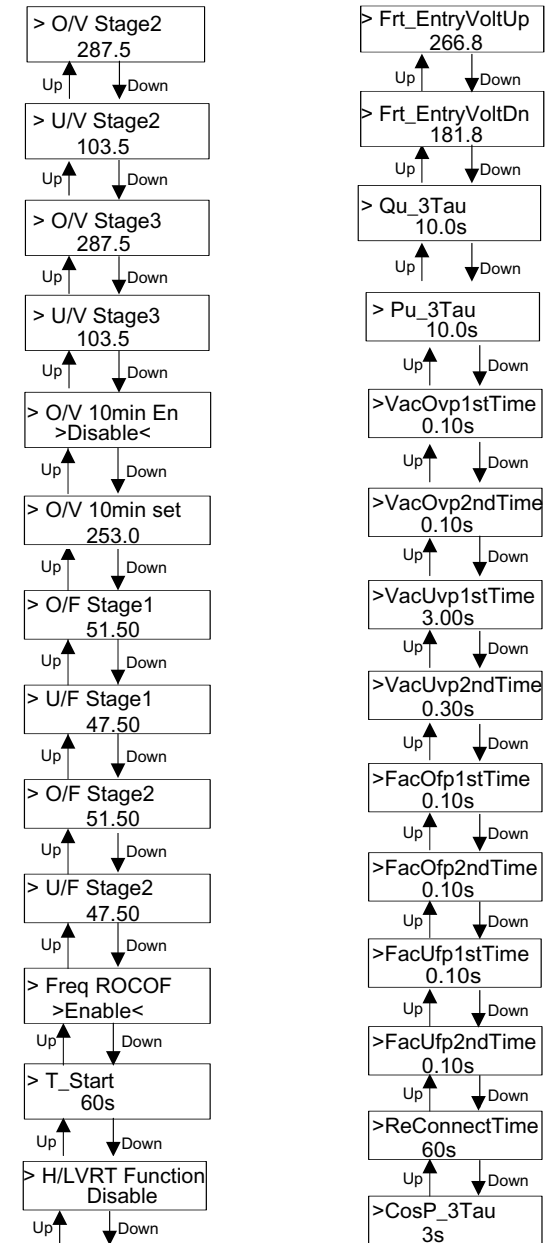
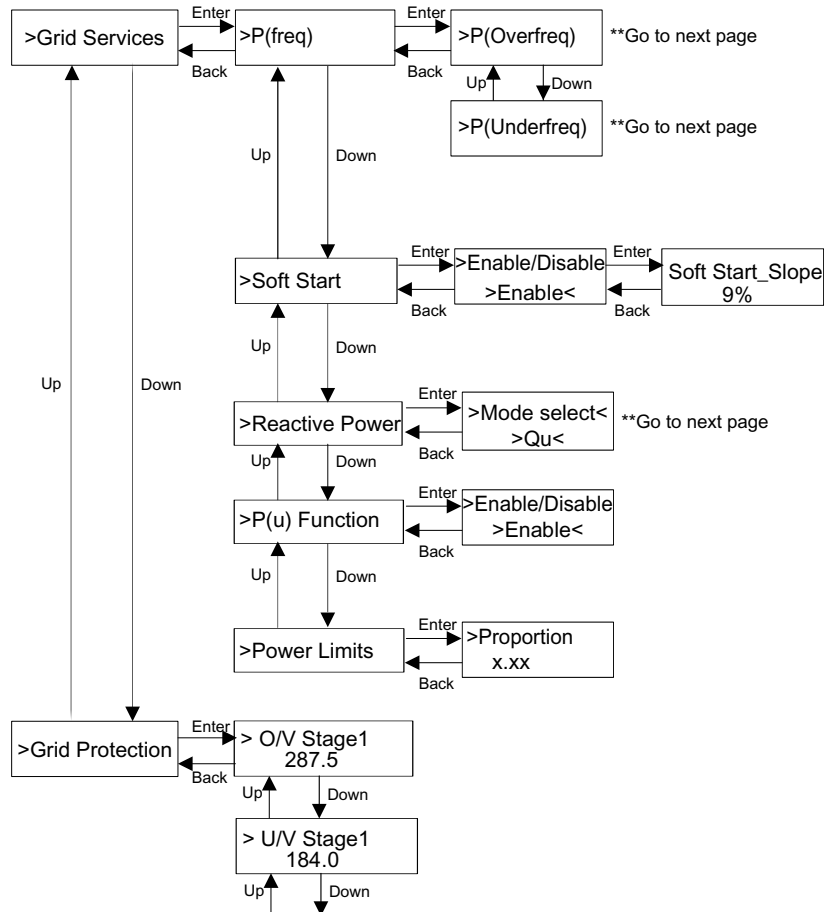

➤ LCD Digital Display

The main interface (Level 1) is the default interface, the inverter will automatically jump to this interface when the system started up successfully or not operated for a period of time.

The interface shows the following information. "Power" means the timely output power; "Pgrid" means the power export to or import from the grid; (Positive value means the energy feeds into the grid, negative value means the energy used from the grid); "Today" means the power generated within the day; "Total" means the power generated until now.

Press "Up" and "Down" to review the information.

Power	0W
Normal	

➤ Menu interface

The menu interface (Level 2) is a transfer interface for the user to get into other interface to finish the setting or get the information.

-User can get into this interface by long pressing "Down" button when LCD displays the main interface.

-User can select by moving the cursor with function button, and long press "Down" to confirm.

= = = = Menu = = = =

> Status
Language

• Status

The status function contains two aspects, the grid and the solar.

Press "Up" and "Down" to select and long press "down" to confirm the selection, long press "Up" to return to Menu.

= = = = Status = = = =

> Grid
Solar

a) Grid

This status shows the current condition of the AC output port of the inverter, such as voltage, current, output power and grid power. "Pout" measures the output of the inverter, "Pgrid" measures power export to or import from the grid. Positive value means the power feeds into the grid, negative value means the power used from the grid.

Press "Up" and "Down" button to review the parameter, long press "up" to return to Status .

= = = = Grid = = = =

> Ua	0.0V
Ia	0.0A

*

b) Solar

This status shows the real time PV condition of the system, such as input voltage, current and power situation of each PV input.

Press "Up" and "Down" button to review parameter, long Press "Up" to return to Status.

= = = = Solar = = = =

U1	0.0V
I 1	0.0A

*

• Language

The function refers to select a language from English, German, Polish, French, Portuguese, etc.

= = = = Language = = = =

> English
German

• Date Time

This interface is for the user to set the system date and time. Increase or decrease the word by pressing "Up" or "Down" button. Press "Down" to confirm and alternate to next word. After all the words are confirmed. Long press "Down" to enter the date and time.

= = = = Date Time = = = =

>2021- 01 -01
00:00

- Settings

Setting function is used for setting the inverter for safety, connection, Grid and so on.

- * Password

The default password is "2014" for the installer, which only allows the installer to review and modify necessary settings complying to the local rules and regulations. If further advanced setting is required, please contact the distributor or us for assistance. We need to increase or decrease the word by pressing up or down button. Press "Down" to confirm an alternate to the next word. After word is confirmed, long press "Down" to enter password.

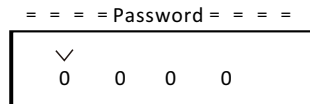

When inputting the password, the information of the LCD interface is shown as below.

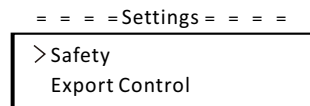

a) Safety

The user can set the safety standard here according to different countries and grid tied standards. There are several standards for choice (May change without notice). In addition, the user has an "UserDefined" option which allows the user to customize relevant parameters within a wider range.

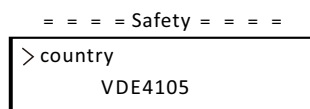

b) Export Control

With this function the inverter can control energy exported to the grid. Whether having this function is based on user's wishes.

Choose "Meter" in "Meter/Disable" means user must install a meter to monitor energy exported to the grid. There are user value and factory value. The factory value is default which can not be changed by user. The user value set by installer must be less than the factory value and within the range of 0 kW to 30 kW.

Choose "Disable" means the function will be shut off.

Press "Up" and "Down" button to select and long press "Down" to confirm.

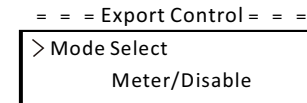

c) DRM Function

Installer can choose "Enable" to control the inverter's power off through the external communication.

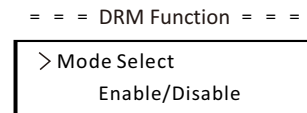

d) Grid Services

Usually end user do not need to set the grid parameters. All default value have been set before leaving factory according to safety rules.

If reset is needed, any changes should be made according to the requirements of local grid.

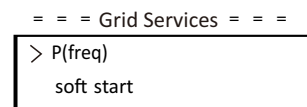

*
*

1. = = = P(freq) = = =
 If reset is needed, any changes should be made according to the requirements of local grid.

> P(Overfreq)
 P(Underfreq)

2. = = = Soft Start = = =
 If reset is needed, any changes should be made according to the requirements of local grid.

> Enable/Disable
 >Disable <

3. Soft Start_Slope
 If set as shown, 9 percent of the rated power increase per minute.

9%

4-1. = = = Reactive Power = = =
 If reset is needed, any changes should be made according to the requirements of local grid.

> Mode Select
 >Off <

Mode Select	Comment
Off	-
Over-Excited	PF value
Under-Excited	PF value
PF(P)	PowerFactor1(2/3/4)
	PowerRatio1(2/3/4)
	EntryVolt
	ExitVolt
Q(u)	Q(u) PowerLockEn
	Q(u) LockIn
	Q(u) LockOut
	Q(u) GridV1/V2/V3/V4
Fix Q Power	Q Power

4-2. Reactive power control, Reactive standard curve $\cos \varphi = f(P)$
 For VDE ARN 4105, curve $\cos \varphi = f(P)$ should refer to curve A. Default values of setting are as shown in curve A.
 For E 8001, curve $\cos \varphi = f(P)$ should refer to curve B. Default values of setting are as shown in curve B.

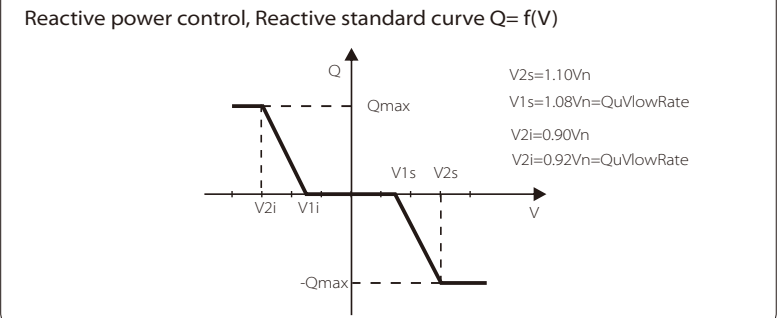
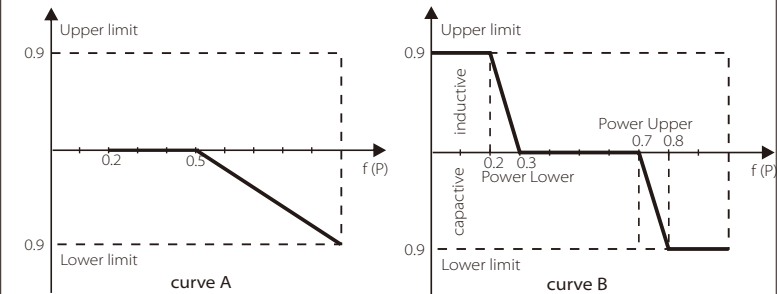

5. = = = P(u) Function = = =
 This function can limit the power. There are several values to be set.

> Enable/Disable
 >Enable <

Enter
 ↓
 Back

> Vw1
 242

6. = = = Power Limits = = =
 User can set the power limit here, the setting value is between 0.00 and 1.00.

> Proportion
 0.40

e) Grid Protection

Usually end user do not need to set the grid Protection. All default value have been set before leaving factory according to safety rules. If reset is needed, any changes should be made according to the requirements of local grid.

```

= = = Grid Protection = = =
> O/V Stage1
    0.0
    
```

f) New Password

The user can set the new password here. We need to increase or decrease the word by pressing "Up" or "Down" button. Long press "Down" to confirm and alternate to next word. After word is confirmed, long press "Down" to reset the password.

```

= = = New Password = = =
1  2  3  4
           ✓
    
```

g) RS485 CommAddr

If "Enable" is selected, the inverter will communicate with the computer, through which the operating status of the inverter can be monitored. When multiple inverters are monitored by one computer, RS485 communication addresses of different inverters need to be set. The default address is "1".

```

= = = RS485 CommAddr = = =
> Set Address
    1
    
```

h) ParallelSetting

When the user wants to use the parallel system with Modbus Function, enable this function and complete the settings following the instructions in section "Parallel Connection". If not needed, disable this function.

```

= = = ParallelSetting = = =
> Mode Select
    Disable
    
```

i) Mppt Scan Mode

There are four modes to be selected. "Off", "LowFreqScan", "MidFreqScan", "High FreqScan". It shows the frequency of PV panel scan. If "LowFreqScan" is selected, the inverter will scan the PV panel by low frequency.

```

= = = Mppt Scan Mode = = =
> Mode Select
    >Off<
    
```

j) Reset Energy

The user can clear the power energy by this function.

```

= = = Reset Energy = = =
> Reset
    >YES/NO<
    
```

k) Reset Meter

The user can clear the meter energy by this function. Press "Up" or "Down" button to select and long press "Down" to confirm. (The user can select "Yes" to reset meter if the user uses meter.)

```

= = = Reset Meter = = =
> Reset
    >YES/NO<
    
```

l) Reset Errorlog

The user can clear the errorlogs by this function. Press "Up" or "Down" button to select and long press "Down" to confirm.

```

= = = Reset Errorlog = = =
> Reset
    >YES/NO<
    
```

m) Reset WiFi

The user can restart the WiFi by this function.

```

= = = Reset WiFi = = =
> Reset
    >YES/NO<
    
```

n) Machine Type

The user can check the Machine Type by this function.

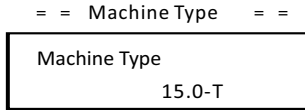

o) PV Connection

The user can select the PV connection type by this function.

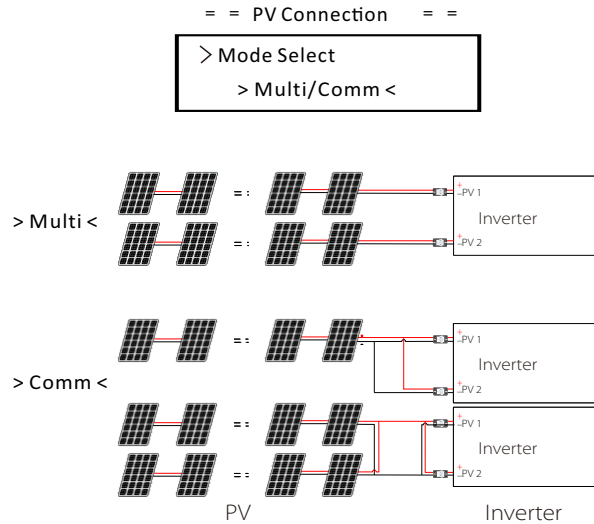

p) Nline Control

The user can enable or disable the Nline Control by this function. If the N wire of the AC side were connected, select "Enable"; if not connected, select "Disable".

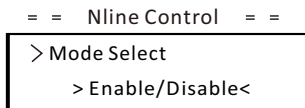

q) Dry Contact

The user can use the Dry Contact to connect SG Ready heat pump by this function via Adapter Box.



There are three functions(Disable/Manual/Smart Save) which can be selected for Load Management. "Disable" means the heat pump is off. When "Manual" is selected the user can control the external relay to remain close or open manually. "Smart Save" mode can set the values of the heat pump's on/off time and conditions, operating modes.

If the user uses the inverter dry contacts to control heat pump through Adapter box, please refer to the Adapter Box Quick Installation Guide to set the parameters here.

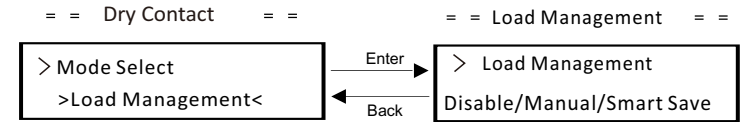

r) Modbus Function

Select "EV Charger" for communication with the EV-Charger, select "COM485" for communication with other devices.

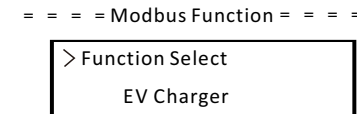

• Meter Energy

The user can check the import and export energy by this function. There are four parameters: "Today Import", "Total Import", "Today Export", "Total Export". Press "Up" and "Down" to review the values.

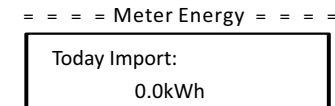

- Error Logs

The Error log contains error information happened. It can record six items at most. Press "Up" and "Down" button to review parameter. Long press "Up" to return to the main interface.

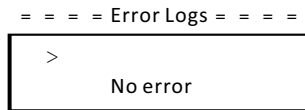

- About

This interface shows information of the inverter, include "Product SN", "Master", "Manager" and "Internal Code".

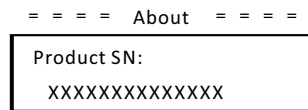

8 Troubleshooting

8.1 Troubleshooting

This section contains information and procedures for solving possible problems with the series inverters, and provides you with troubleshooting tips to identify and solve most problems that could occur with the series inverters.

This section will help you narrow down the source of any problems you may encounter. Please read the following troubleshooting steps.

Check warnings or fault messages on System Control Panel or Fault codes on the inverter information panel. If a message is displayed, record it before doing anything further.

Attempt the solution indicated in below table.

Faults	Diagnosis and Solution
TzFault	Over Current Fault. -Wait for about 10 seconds to check if the inverter is back to normal. -Disconnect the DC switch and restart the inverter. -Or seek help from us.
GridLostFault	Grid Lost Fault. -Check if the mains cable is loose. -Wait for a while and the system will reconnect when the utility is back to normal. -Or seek help from us.
GridVoltFault	Grid Voltage Out of Range. -Check if the mains cable is loose. -Wait for a while and the system will reconnect when the utility is back to normal. -Or seek help from us.
GridFreqFault	Grid Frequency Out of Range. -Wait for a while and the system will reconnect when the utility is back to normal. -Or seek help from us.
PWoltFault	PV Voltage Fault. -Check whether the PV is overvoltage. -Or seek help from us.
BusVoltFault	DC Bus Voltage Out of Normal Range. -Check if the PV input voltage is within the operating range of the inverter. -Disconnect PV wiring and reconnect. -Or seek help from us.

Faults	Diagnosis and Solution
GridVolt10MFault	Grid Overvoltage for Ten Minutes Fault. -The system will reconnect when the utility is back to normal. -Or seek help from us.
DclnJOCp	DCI Overcurrent Protection Fault. -Wait for a while to check if the inverter is back to normal. -Or seek help from us.
HardLimitFault	Hard Limit Fault (in Australian standard). -Wait for a while to check if the inverter is back to normal. -Or seek help from us.
SW OCP Fault	Software Overcurrent Protection Fault. -Wait for a while to check if the inverter is back to normal. -Disconnect PV and grid, then reconnect. -Or seek help from us.
ResidualOCP	Overcurrent Protection Fault. -Check the connections of the inverter. -Wait for a while to check if the inverter is back to normal. -Or seek help from us.
IsoFault	Isolation Fault. -Check the connections of the inverter. -Or seek help from us.
OverTempFault	Over Temperature Fault. -Check if the inverter and the ambient temperature exceeds the operating range. -Or seek help from us.
LowTempFault	Low Temperature Fault. -Check if the ambient temperature is too low. -Or seek help from us.
InternalComFault	Internal Communication Fault. -Restart the inverter to check if it is back to normal. -Update the ARM software or reburn the program. -Or seek help from us.
FanFault	Fan Fault. -Check whether the fan is faulty or damaged. -Or seek help from us.
AcTerminalOTP	AC Terminal Overtemperature Fault. -Check if the AC terminals are tightly connected. -Check if the ambient temperature exceeds the operating range. -Or seek help from us.

Faults	Diagnosis and Solution
EepromFault	DSP EEPROM Fault. -Disconnect PV wiring and reconnect. -Or seek help from us.
RcDeviceFault	Residual Current Device Fault. -Restart the inverter. -Update the ARM software or reburn the program. -Or seek help from us.
PvConnDirFault	PV Direction Fault. -Check if the PV+/- sides are connected correctly. -Or seek help from us.
GridRelayFault	Relay Fault. -Check the grid connection. -Restart the inverter. -Or seek help from us.
OtherDeviceFault	Model Incorrectly Set Fault. -Seek help from us.
Mgr EEPROM Fault	ARM EEPROM Fault. -Disconnect PV and grid, then reconnect. -Or seek help from us.
Meter Fault	Meter Fault. -Check the connection of the meter. -Check if the meter is in working order. -Or seek help from us.
Fan1 Warning	External Fan 1 Abnormal Warning. -Check if the fan is working. -Or seek help from us.
Fan2 Warning	External Fan 2 Abnormal Warning. -Check if the fan is working. -Or seek help from us.
PowerTypeFault	Power Type Fault. -Check the version of ARM and DSP. -Check the product SN number. -Or seek help from us.

- If the information panel of your inverter does not show the Fault light, check the following list to make sure that the present state of the installation allows proper operation of the unit.
 - Is the inverter located in a clean, dry, adequately ventilated place?
 - Have the DC input breakers been opened?
 - Are the specification and length of the cables suitable?
 - Are the input and output connections and wiring in good condition?
 - Are the configuration settings correct for your particular installation?
 - Are the display panel and the communications cable properly connected and undamaged?

Contact our Customer Service for further assistance. Please be prepared to describe details of your system installation and provide model and serial number of the unit.

8.2 Routine Maintenance

Regular safety check and maintenance are required.

► *Safety checks*

Safety checks should be performed at least every 12 months by manufacturer's qualified person who has adequate training, knowledge, and practical experience to perform these tests. The data should be recorded in an equipment log. If the device is not functioning properly or fails any of test, the device has to be repaired. For safety check details, refer to this manual, section 2 Safety instruction and EC Directives.

► *Maintain periodically*

Only qualified personnel may perform the following works.
During the process of using the inverter, the manage person shall examine and maintain the machine regularly. The concrete operations are as follows.

- 1: Check that if the cooling fins on the rear of the inverter are covered by dirt, and the machine should be cleaned and absorbed dust when necessary. This work shall be performed from time to time.
- 2: Check that if the indicators of the inverter are in normal state, check if the keys of the inverter are in normal state, check if the display of the inverter is normal. This check should be performed at least every 6 months.
- 3: Check that if the input and output wires are damaged or aged. This check should be performed at least every 6 months.
- 4: Clean the inverter panels and check their security. This should be carried out at least every 6 months.

9 Decommissioning

9.1 Dismantling the Inverter

- Disconnect the inverter from DC Input and AC output.
- Wait for at least 5 minutes for de-energizing.
- Disconnect communication and optional connection wirings.
- Remove the inverter from the bracket.
- Remove the bracket if necessary.

9.2 Packaging

If possible, please pack the inverter with the original packaging.

If it is no longer available, you can also use an equivalent carton that meets the following requirements.

- Suitable for loads more than 30 kg.
- With handle.
- Can be fully closed.

9.3 Storage and Transportation

Store the inverter in dry place where ambient temperatures are always between -30°C and +60°C. Take care of the inverter during the storage and transportation, keep less than 4 cartons in one stack.

9.4 Waste Disposal

When the inverter or other related components need to be disposed, have it carried out according to local waste handling regulations. Please be sure to deliver wasted inverters and packing materials to certain site where can assist relevant department to dispose and recycle.

10 Disclaimer

The inverters shall be transported, used and operated under restricted conditions. We will not provide any service, technical support or compensation in case of the following circumstances, including but not limited to:

- The inverter is damaged by force majeure (such as earthquake, flooding, thunderstorm, lighting, fire hazard, volcanic eruption, etc.);
 - The inverter's warranty is expired, but not extended;
 - The inverter's SN, warranty card or invoice cannot be provided;
 - The inverter is damaged by man-made cause;
 - The inverter is used or operated against any items in local policy;
 - The installation, configuration and commissioning of the inverter doesn't meet the requirements mentioned in this manual;
 - The inverter is installed, refitted or operated in improper ways;
 - The inverter is installed, operated under improper environment or electrical condition;
 - The inverter is changed, updated or disassembled on hardware or software without authority from us;
 - The communication protocol from other illegal channels is used; and
 - The monitoring or control system is used without authority from us.
- SolaX reserves the right for the final explanation.

Appendix: Australian Version DC Switch

There are two kinds of DC switch for the series inverters:

- General version (without lock; applied to most countries and regions);
- Australian version (with lock; applied to Australia and New Zealand).

a. States of the Australian version DC switch

For the Australian version DC switch, there are 3 states: ON, OFF and OFF+Lock and the default state is OFF.

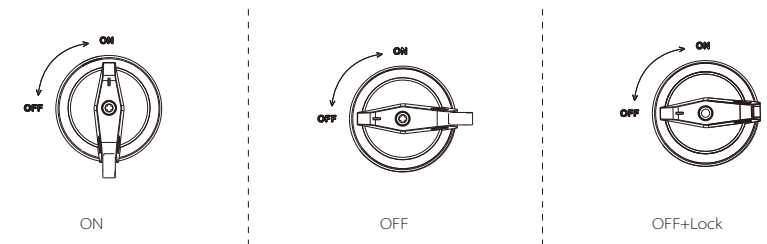

b. Operation of the Australian version DC switch

- To turn on the Australian version DC switch:
Rotate from OFF state to ON state.

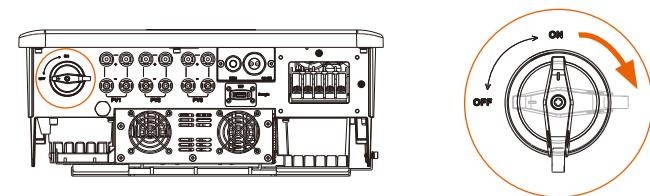

- To turn off the Australian version DC switch:
Rotate from ON state to OFF state.

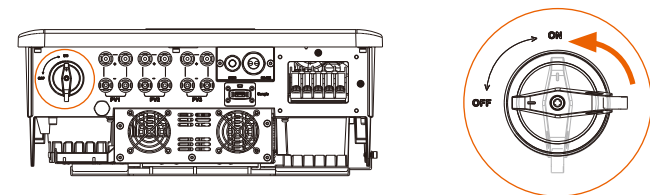

- To lock the Australian version DC switch:
Make sure the DC switch is OFF state, push in the buckle as shown below, and then secure it with a lock (Please prepare a lock in advance.)

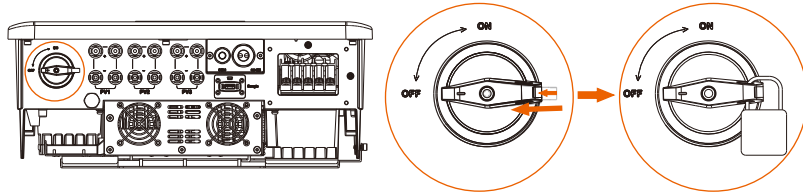

- To unlock the Australian version DC switch:
Remove the lock and wait for it to return to OFF state.

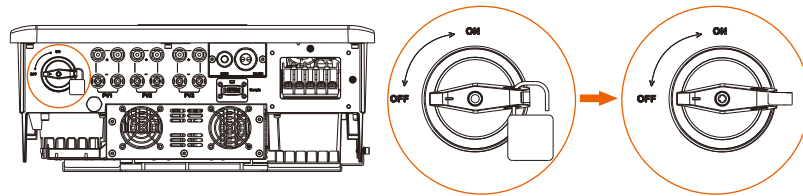

Warranty Registration Form



For Customer (Compulsory)

Name Country

Phone Number Email

Address

State Zip Code

Product Serial Number

Date of Commissioning

Installation Company Name

Installer Name Electrician License No.

For Installer

Module (If Any)

Module Brand

Module Size(W)

Number of String Number of Panel Per String

Battery (If Any)

Battery Type

Brand

Number of Battery Attached

Date of Delivery Signature

Please visit our warranty website: <https://www.solaxcloud.com/#/warranty> to complete the online warranty registration or use your mobile phone to scan the QR code to register.

For more detailed warranty terms, please visit SolaX official website: www.solaxpower.com to check it.





PLEASE REGISTER THE WARRANTY IMMEDIATELY AFTER INSTALLATION!
GET YOUR WARRANTY CERTIFICATE FROM SOLAX!
KEEP YOUR INVERTER ONLINE & WIN SOLAX POINTS!

1

Open your camera app and point your device at the QR code



2

Wait for the camera to recognize the QR code



3

Click banner or notification when it appears on the screen



4

Warranty registration page will be loaded automatically

